



Introduction to Architectural Paving & Segmental Retaining Walls

©2021 Unilock. The material contained in this course was researched, assembled, and produced by Unilock and remains its property. Questions or concerns about the content of this course should be directed to the program instructor. This multimedia product is the copyright of AEC Daily.

AIA Continuing Education Provider

This Online Learning Seminar is available through a professional courtesy provided by:

UNILOCK®

Unilock

401 The West Mall, Suite 610

Toronto, ON M9C 5J5

Regional Offices: Boston, Detroit, Chicago,
New York, Cleveland, Toronto

Tel: 1-800-UNILOCK

Email: customerservice@unilock.com

Web: <https://commercial.unilock.com>

START

powered by  www.aecdaily.com

Introduction to Architectural Paving & Segmental Retaining Walls

To ensure the current status of this course, including relevant association approvals, please view the course details [here](#).

AIA
Continuing
Education
Provider

The American Institute of Architects

Course No. AEC1619

This program qualifies for 1.25 LU/HSW Hours

Course Expiry Date: 04/07/2024

AEC Daily Corporation is a registered provider of AIA-approved continuing education under Provider Number J624. All registered AIA CES Providers must comply with the AIA Standards for Continuing Education Programs. Any questions or concerns about this provider or this learning program may be sent to AIA CES (cessupport@aia.org or (800) AIA 3837, Option 3).

This learning program is registered with AIA CES for continuing professional education. As such, it does not include content that may be deemed or construed to be an approval or endorsement by the AIA of any material of construction or any method or manner of handling, using, distributing, or dealing in any material or product.

AIA continuing education credit has been reviewed and approved by AIA CES. Learners must complete the entire learning program to receive continuing education credit. AIA continuing education Learning Units earned upon completion of this course will be reported to AIA CES for AIA members. Certificates of Completion for both AIA members and non-AIA members are available upon completion of the test.

AEC Daily Corporation has met the standards and requirements of the Registered Continuing Education Program. Credit earned on completion of this program will be reported to RCEP at RCEP.net. A certificate of completion will be issued to each participant. As such, it does not include content that may be deemed or construed to be an approval or endorsement by the RCEP.



REGISTERED CONTINUING EDUCATION PROGRAM

How to Use This Online Learning Course

To **view** this course, use the **arrows** at the bottom of each slide or the up and down arrow keys on your keyboard.

To **print or exit** the course at any time, press the **ESC** key on your keyboard. This will minimize the full-screen presentation and display the menu bar.

Within this course is a  **test password** that you will be required to enter in order to proceed with the online test. Please be sure to remember or write down this test password so that you have it available for the test.

To receive a **certificate** indicating course completion, refer to the instructions at the end of the course.

For **additional information** and postseminar assistance, click on any of the logos and icons within a page or any of the links at the top of each page.

Purpose and Learning Objectives

Purpose:

Paving products comprise an important part of both the functionality and aesthetic of exterior spaces, including urban plazas, streetscapes, walkways, patios, and amenity spaces. This course provides an overview of architectural paving and segmental retaining walls (SRWs) as two primary applications of hardscaping products in these spaces. The course introduces architectural paving and its components, manufacturing, and products and then focuses on the benefits, construction, and available types of SRWs. Case study examples of both architectural paving and SRWs are provided to engage and inspire learners as to the applications, functionality, and aesthetic possibilities of hardscaping products.

Learning Objectives:

At the end of this program, participants will be able to:

- define and discuss the benefits of architectural paving and segmental retaining walls (SRWs)
- state the components of concrete and their respective functions
- explain the manufacturing processes, standards, and factors that contribute to a quality paver product and identify various finishes/shapes of available concrete pavers
- name and discuss the different types of segmental retaining wall construction, and
- discuss the various SRWs available in the North American market and the benefits of designing with SRWs.

Contents

Part 1: Architectural Paving

- Introduction and History
- Concrete Paver Components
- Manufacturing Processes & Standards
- Paver Finishes, Shapes, & Sizes
- Architectural Paving Projects

Part 2: Segmental Retaining Walls (SRWs)

- Introduction to SRWs
- Types of SRW Construction
- SRWs Available in the North American Market
- Benefits of Designing with SRWs
- SRW Projects

Resources





Part 1: Architectural Paving

What Is Architectural Paving?

Architectural paving refers to manufactured segmental concrete paving stones that are commonly used in exterior locations such as urban plazas, streetscapes, walkways, patios, and amenity spaces.

Architectural pavers can be used in various applications:

- Pedestrian
- Light-duty and heavy-duty vehicular
- Roof deck

Benefits of architectural paving:

- These paving systems provide strength, durability, and flexibility.
- The availability of shapes, sizes, colors, and finishes offers endless design possibilities.
- Architectural pavers also allow for ease of maintenance and repairs.

A Brief History of Segmental Paving in North America

Pavers were introduced into the North American market in the 1970s by Unilock founder Ed Bryant. The first stones were made in Barrie, Ontario. At that time, natural (gray) colored pavers were the only available option. Since then, the concrete paver has evolved through a number of innovative technologies, which were first introduced by Unilock, as shown at right.



Timeline: Paver Evolution in North America

1973

- First generation, standard finish pavers introduced

1991

- First permeable pavers introduced

1992

- Introduction of pavers manufactured with face mix technology

1994

- Tumbled/weathered pavers brought to market. Revolutionized the industry by tumbling concrete pavers

2004

- First pavers to be manufactured with a advanced casting (wetcast) and advanced surface technologies

Concrete Paver Components



Aggregates

The combination and proper blending of coarse and fine aggregates in a concrete mix design is vital to achieve high strength, a low moisture absorption rate, and good surface texture. These characteristics lead to a durable, high-quality product.

The blend of large and small aggregates as shown to the right conforms to the “M curve” on the sieve analysis and provides the balance required.

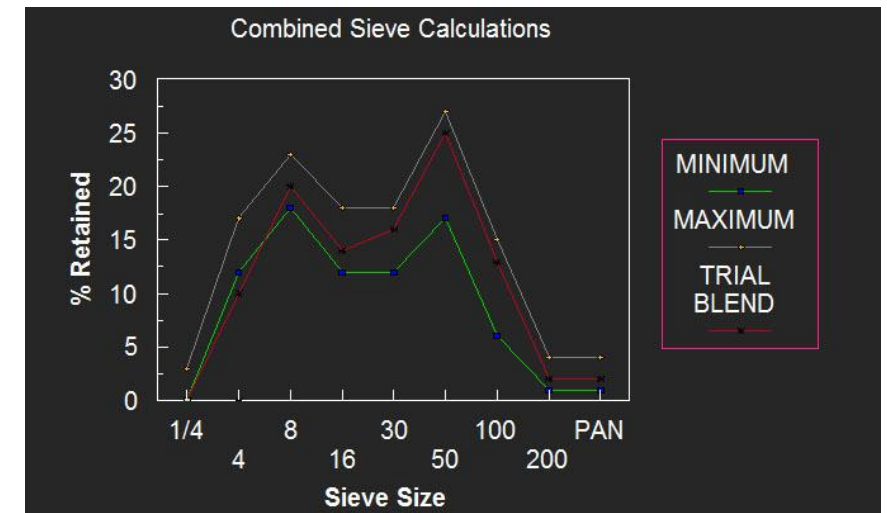

Cement

Cement acts as the glue within the mix, bonding the particles of coarse and fine aggregates.

When aggregate mix designs use a large amount of fine aggregates, more cement is required to coat each aggregate particle compared to the amount of cement needed with larger aggregate particles.

The more cement used in the mix, the more expensive the product becomes. For this reason, the proper balance of aggregates is also key to producing quality, cost-effective material.



Concrete Mix Designs

As % of fine aggregates  , % of cement 

AND

As % of coarse aggregates  , % of cement 

Supplementary Materials

Cement can be partially replaced with supplementary materials known as pozzolans, which come in various forms. The more common ones include these:

- **Fly ashes type C and F:** residue from combustion of pulverized coal
- **Silica fume:** residue resulting from the production of silica
- **Slag cement:** ground, granulated blast furnace (GGBF) slag, formed by rapidly chilling molten blast furnace slag

The use of supplementary materials decreases the environmental impact associated with concrete production by reducing energy use and CO₂ emissions.

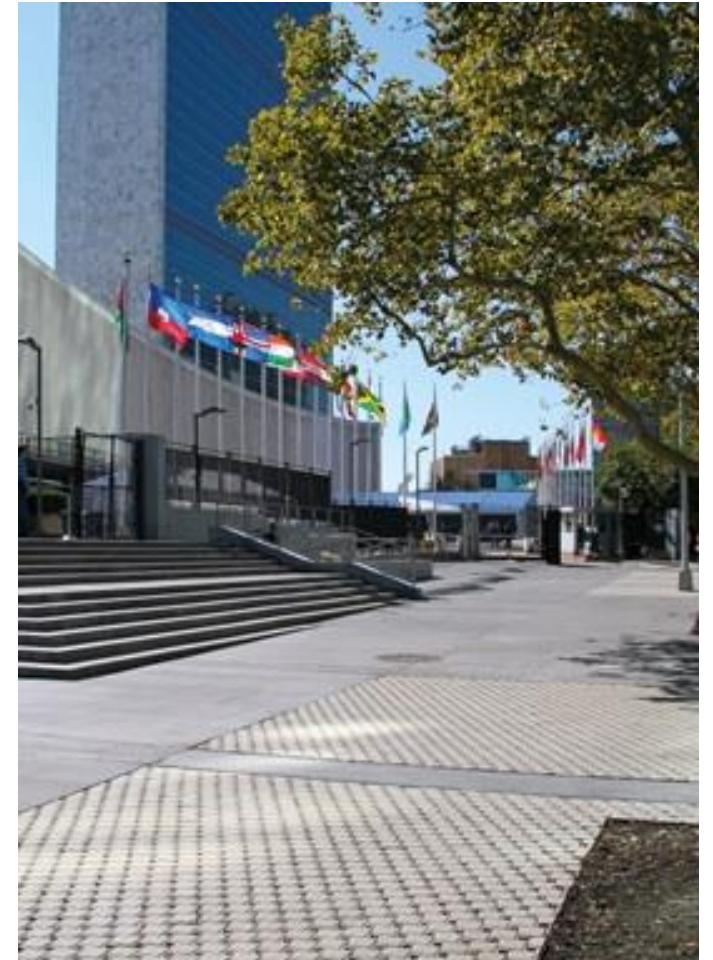

Pavers made with recycled glass pozzolans

Admixtures

Admixtures are dry or liquid additives that are added to the concrete mix to augment performance characteristics based on application requirements.

Admixtures are used to:

- plasticize the concrete to make it more fluid, which assists in the mold-filling process and increases densification
- help control efflorescence, and
- improve the concrete quality.

Admixtures may contain air entrainers, water reducers, super plasticizers, retarders, accelerators, viscosity modifiers, alkali-silica reactivity reducers, shrinkage reducers, expansion agents, efflorescence controllers, etc.

Some contain chemicals that repel water from the concrete after curing. These water-repellent admixtures can minimize water movement within the concrete and reduce water absorption and efflorescence. Calcium stearates are one type of water repellent that work by creating hydrophobic deposits within the concrete. Because they are not permanently bonded to the concrete, they may break down over time. Silane/siloxane is now another commonly used hydrophobic admixture that permanently bonds to the concrete and has longer-term durability.

Pigments

The last component we'll review is pigments. Pavers are available in a wide palette of colors to complement any design vision. Color is achieved typically through tinting the concrete. One method of tinting is through the use of iron oxide additives. Again, aggregate particle size has to be considered. Smaller particle size in the batch allows for higher-strength tinting, lower loading, and cost savings.

Note: There comes a point where putting more pigment into the batch has no effect on color. See images below.

COLOR INTENSITY CURVES ON CONCRETE SPECIMENS

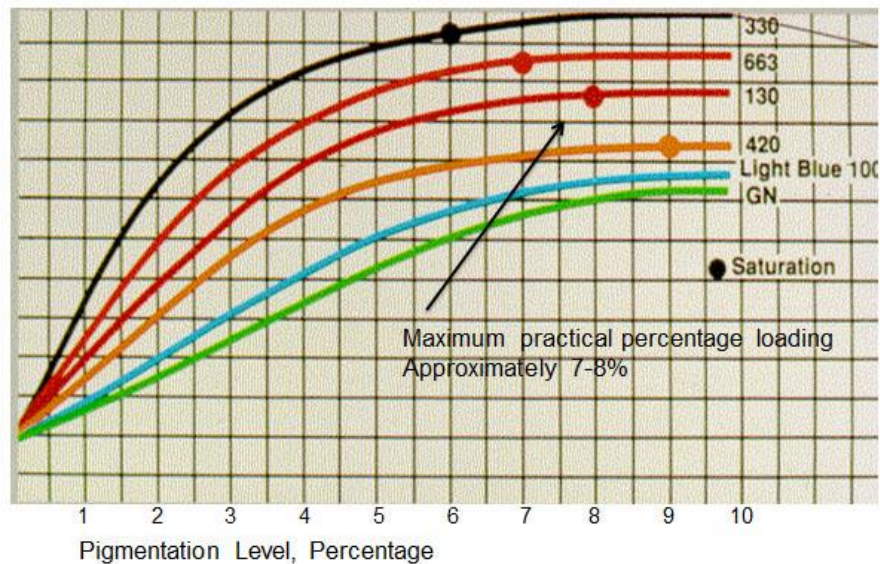

The color saturation point is illustrated in the graph and ranges from 6% to 9% depending on the color of the pigment.

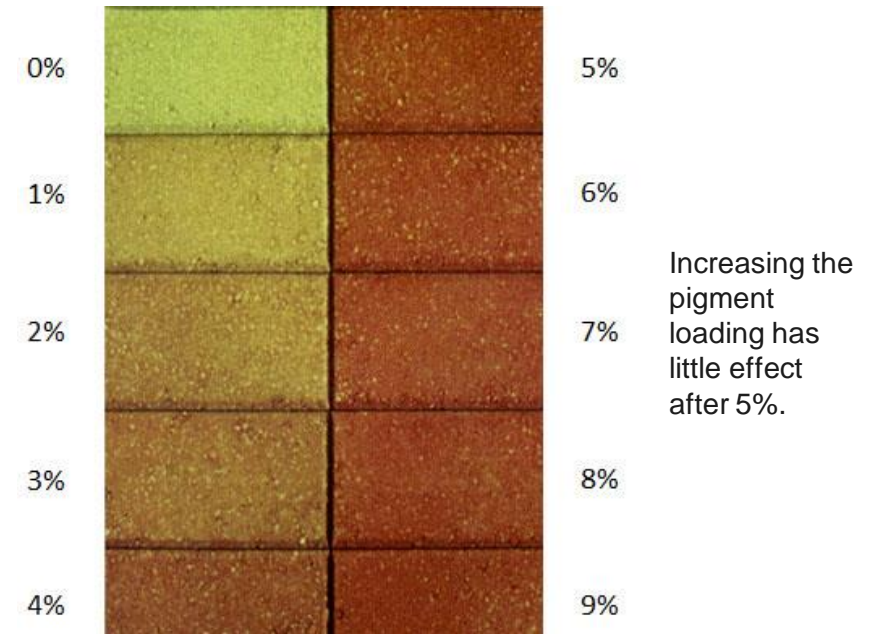

Pigments

Aggregates from different regions or quarries may have a significant effect on the final color even when the same pigment is used.

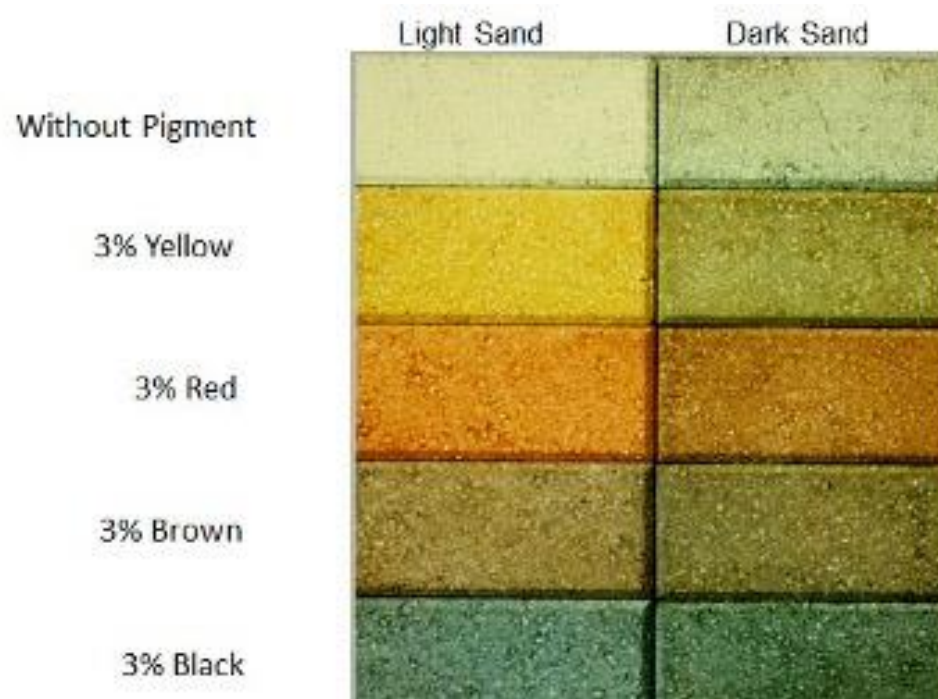

This photo shows the difference a light sand and dark sand have with the same pigment loading.

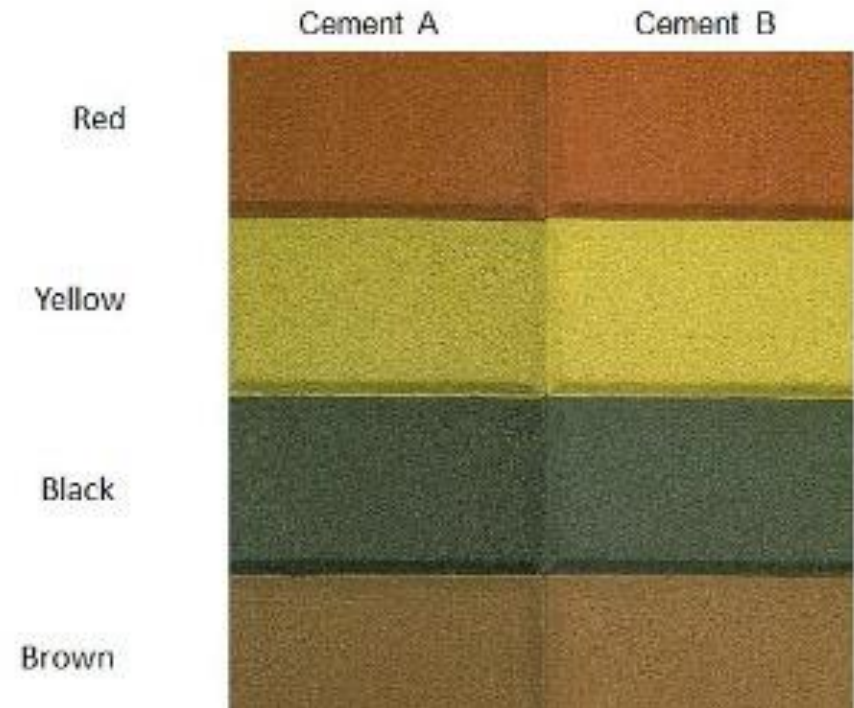

This photo shows that different cements also impact the concrete color.

Review Question

What are the uses and benefits of architectural paving?

Answer

What are the uses and benefits of architectural paving?

Architectural pavers can be used in various applications:

- Pedestrian
- Light-duty and heavy-duty vehicular
- Roof deck

Benefits of architectural paving:

- These paving systems provide strength, durability, and flexibility.
- The availability of shapes, sizes, colors, and finishes offers endless design possibilities.
- Architectural pavers also allow for ease of maintenance and repairs.

Manufacturing Processes & Standards

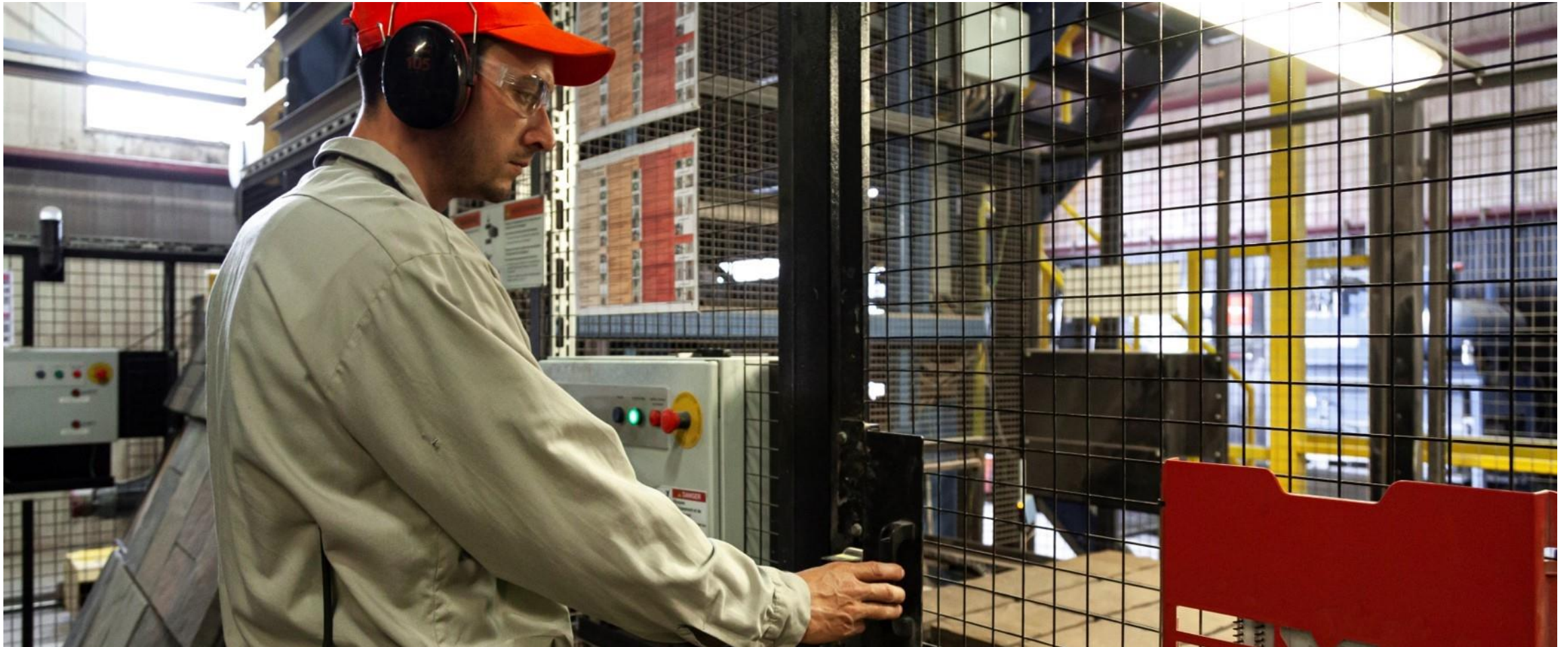

Manufacturing Processes: Dry Cast / Wet Cast

There are two types of manufacturing processes for pavers: dry cast and wet cast.



Dry Cast



Wet Cast

Dry Cast Products

Dry cast products have less water in their mix design compared to wet cast products.

The dry cast mix is put into rigid steel molds, vibrated, compacted, and then cured in kilns.

Dry cast products are typically available with the following finishes:

- Standard
- Tumbled
- Smooth
- Brushed
- Exposed aggregate
- Factory sealed



Wet Cast Products

Wet cast products have more water in the mix and are poured into flexible polyurethane molds, allowing manufacturers to create products that resemble authentic cobblestones, old brick, or natural stone.

Wet cast products are available in a variety of styles.



Face Mix Technology

Typically used for dry cast products, although also used for wet cast products, face mix technology is a manufacturing process that provides a more durable product with long-lasting color. Face mix products are made with a top layer of specialized concrete mix representing about 10–12% of the total depth of the product. This layer—made up of either normal fine aggregates or a blend of high-quality minerals and aggregates such as granite or quartz—has a higher cement content with reduced water absorption. Larger aggregates are used in the base mix, yielding a high-strength product.

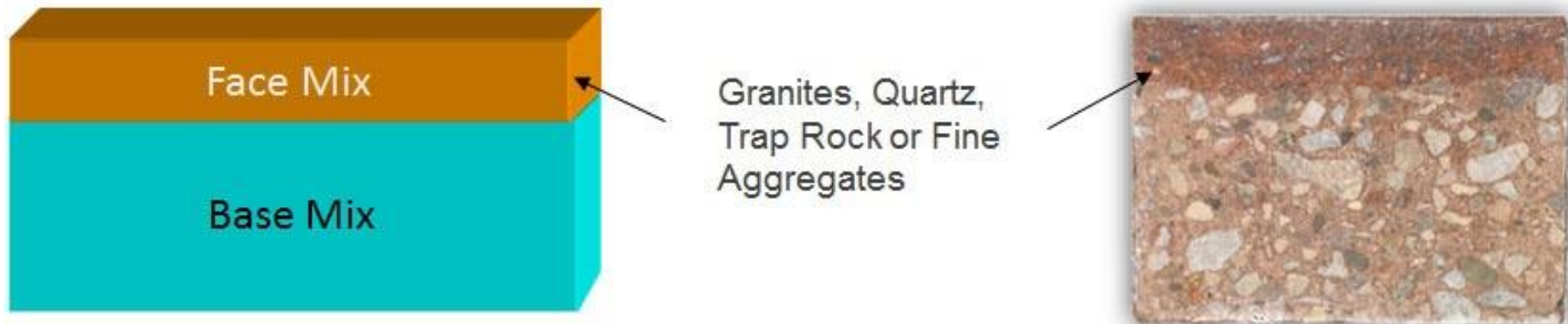

Face Mix Technology

Traditional pavers, as seen on the left, are thru-mixed with the same combination of large and small aggregates from the top to the bottom of the paver. Face mix uses a blend of smaller aggregates at the surface of the paver and can be used for both dry cast and wet cast processes.

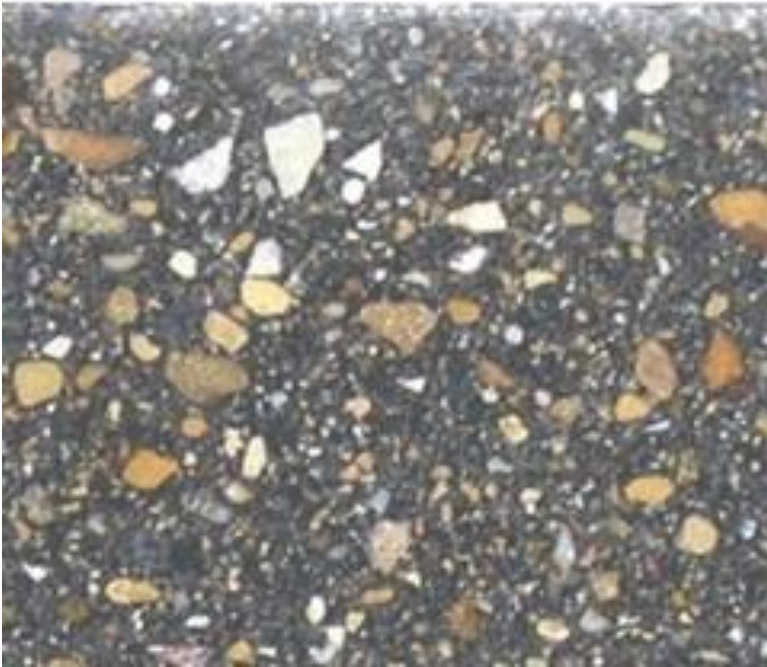

Traditional Stone



Face Mix on Dry Cast

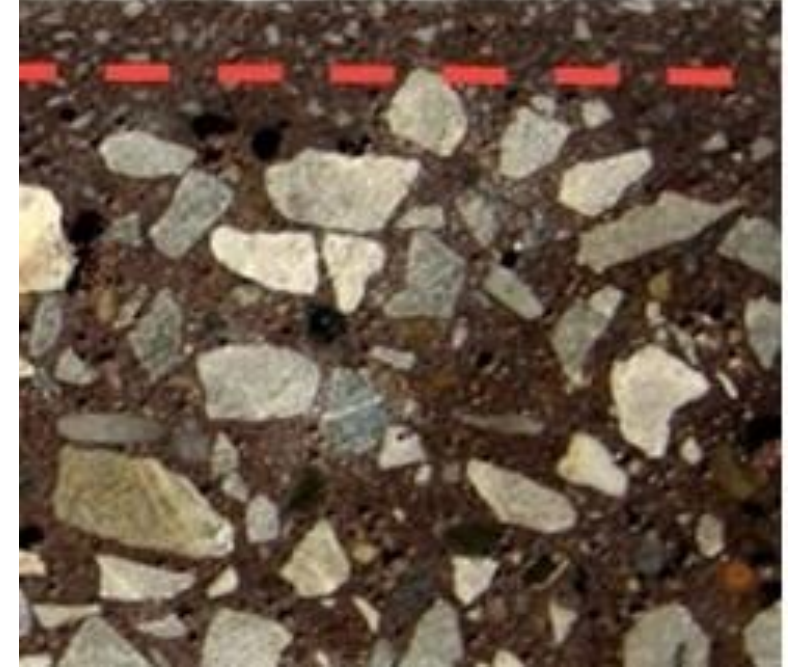

Face Mix on Wet Cast

Benefits of Face Mix Technology

Face mix products will still wear on the surface, but the composition of smaller aggregates ensures that, as opposed to thru-mix products, the color and tight finish remain. Because there are no larger aggregates at the surface of these pavers, the surface finish remains even with wear. This image shows the tight finish with beautiful color distribution that comes with face mix technology versus the less seamless thru-mix method.



Manufacturing Standards

Several factors contribute to a durable and quality paver product:

High compressive strength for high concrete density

- Minimum 8,000 psi for pavers and 5,000 psi for walls

Low water absorption percentage for good freeze–thaw durability

- 5% average or less (7% maximum)

Excellent dimensional control for ease of installation

- Height +/- 1.0 mm

Pleasing aesthetics in color and surface texture

Ultimately, a quality paver must have high compressive strength with low water absorption to have good freeze–thaw durability. Dimensional control and high concrete density also provide greater aesthetics by contributing to less wear on the product over time.

Concrete Density

This chart illustrates the relationship between concrete density, compressive strength, and absorption percentage.

Generally, higher densities increase compressive strength to withstand higher loads and prevent cracking and breaking. Higher densities also lower the water absorption rate. This reduces wear from freeze–thaw cycles and creates a long-lasting paver. When the compressive strength is roughly 10,400 psi (blue line), the absorption rate is just over four percent (red line).

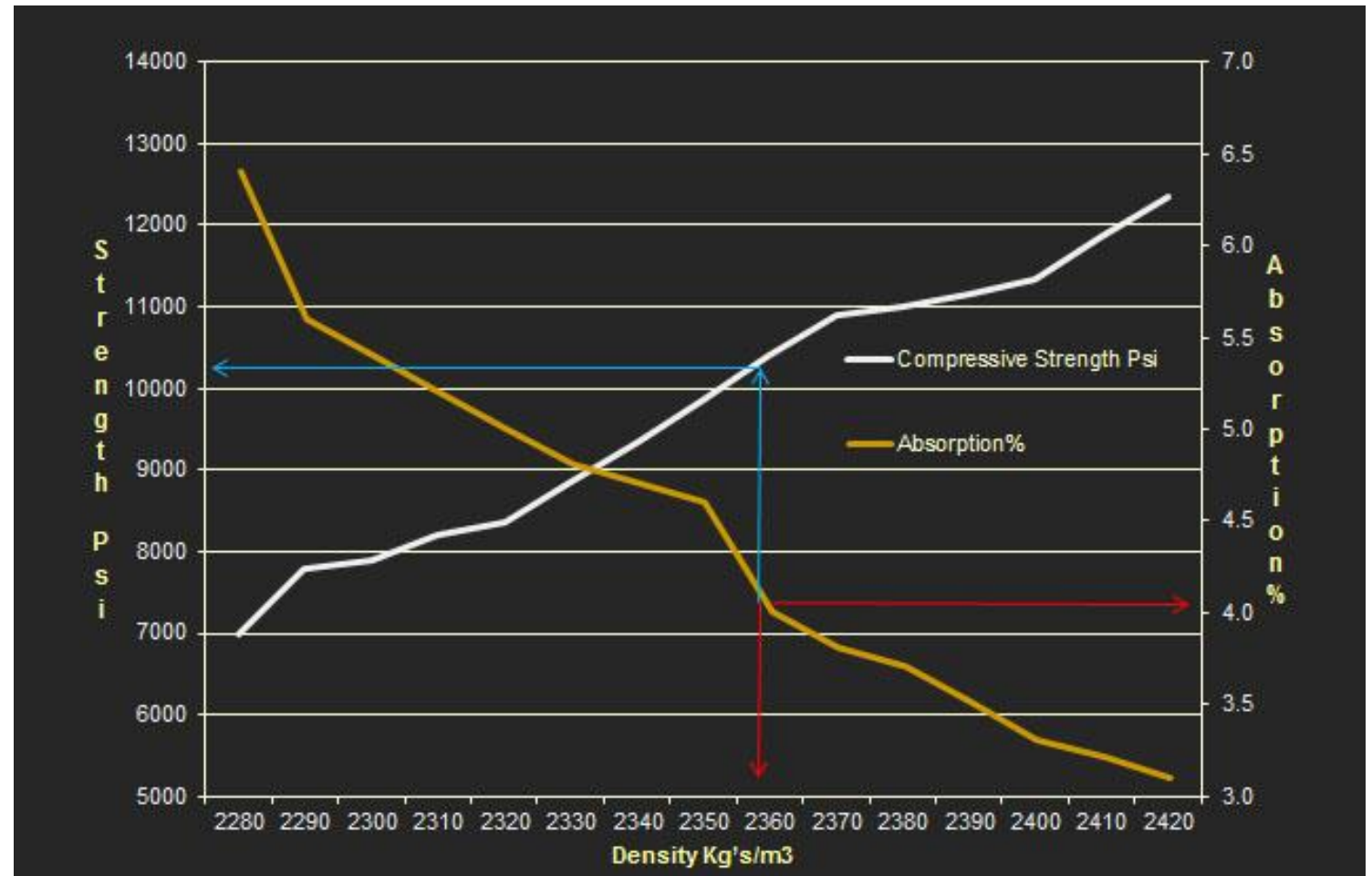

Absorption

Absorption is very important to the longevity of a surface. If the paver is allowed to absorb water, when it freezes, it will crack and break. The absorption rate of concrete, clay pavers, and concrete pavers is contrasted below.

Concrete



2,500 to 5,500 psi
15%+ Absorption

Clay Pavers



8,000 to 20,000 psi
6–8% Absorption

Concrete Pavers



8,500 to 15,000 psi
4–5% Absorption

CSI Division 32 – Exterior Improvements

Paving stones are covered in Construction Specifications Institute (CSI) Division 32 – Exterior Improvements.

32 14 00 – UNIT PAVING

- **32 14 13 – Precast Concrete Unit Paving**
 - 32 14 13.13 – Interlocking Precast Concrete Unit Paving
 - 32 14 13.16 – Precast Concrete Unit Paving Slabs
 - 32 14 13.19 – Porous Precast Concrete Unit Paving
- **32 14 16 – Brick Unit Paving**
- **32 14 23 – Asphalt Unit Paving**
- **32 14 26 – Wood Paving**
- **32 14 29 – Recycled Rubber Paving**
- **32 14 40 – Stone Paving**
- **32 14 43 – Porous Unit Paving**



ASTM C936

ASTM International C936, “Standard Specification for Solid Concrete Interlocking Paving Units,” is specific to interlocking paving units and the specifications they need to conform to.

ASTM C936 references:

- C140, “Standard Test Methods for Sampling and Testing Concrete Masonry Units and Related Units”: specification related to absorption and compressive strength
- C1645, “Standard Test Method for Freeze–Thaw and Deicing Salt Durability of Solid Concrete Interlocking Paving Units”: specification pertaining to freeze–thaw durability
- C418, “Standard Test Method for Abrasion Resistance of Concrete by Sandblasting”: specification related to abrasion and durability

ASTM C140 / CSA A231.2

Dry cast paver standards are ASTM C140 and CSA A231.2, "Precast Concrete Pavers." These standards require the paver to have the following performance characteristics:

- 8,000 psi average
- 7,200 psi minimum unit
- 5% absorption average (ASTM only)
- 7% absorption maximum (ASTM only)
- Height tolerance less than +/- 1/8"



CSA A231.1

The CSA requirements for both dry cast and wet cast concrete paver slabs are shown here. Note that since ASTM is currently developing a slab standard, some manufacturers follow CSAA231.1, "Precast Concrete Paving Slabs." This standard requires the paver slab to have the following performance characteristics:

- 655 psi flexural strength minimum
- Length and width tolerance less than +/- 3/32"
- Height tolerance less than +/- 1/8"
- Center point load test of pedestal-supported slabs: 1,800 lb



Wet cast paver slab



Dry cast paver slab

Product Testing

Products are individually tested to ensure that they meet industry guidelines. Typical test results are shown in the tables below with key data points highlighted: compressive strength (psi), absorption (%), mass loss at seven freeze–thaw cycles (g/m²), and mass loss at 28 freeze–thaw cycles (g/m²). The highlighted figures are calculated using three separate test results to determine the averages in each category of testing.

TESTING OF SOLID CONCRETE PAVING UNITS

Compressive Strength – test date 5/30/13 at 23 days of age

Specimen No.	1	2	3	Average
Received weight, lbs	5.722	5.580	5.698	5.667
Width, inches (mm)	3.813 (96.9)	3.807 (96.7)	3.813 (96.9)	3.811 (96.8)
Thickness, inches (mm)			67 (60.1)	2.362 (60.0)
Length, inches (mm)			19 (196.8)	7.750 (196.9)
Aspect Ratio			0.621	0.620
Height after capping, inches			2.453	2.453
Average cap thickness, inches	0.044	0.049	0.043	0.045
Net Area, in ²	29.59	29.48	29.55	29.54
Maximum load, lbs	366,030	302,110	347,690	338,610
Aspect Ratio Factor	1.008	1.007	1.009	1.008
Compressive Strength, psi			11,870	11,550

Absorption and Density

Specimen No.	4	5	6	Average
Received weight, lbs			5.688	5.659
Immersed weight, lbs			3.272	3.259
Saturated weight (SSD), lbs			5.778	5.757
Oven dry weight, lbs			5.546	5.519
Absorption, %	4.1	4.0	4.2	4.3
Absorption, pcf	5.7	6.3	5.8	5.9
Density, pcf	139.0	136.6	138.1	137.9

Measures the compressive strength of the paver.

Measures the amount of water/moisture absorbed by the product as a percentage of its density.

These results meet the compressive strength and absorption requirements of ASTM C936-12. Tests were performed in accordance with ASTM C140-13.

Freeze-Thaw Testing of Concrete Pavers – ASTM C1645-11

Specimen No.	7	8	9	Average
Received weight, g	2,585	2,543	2,541	2,556
Width, mm	96.8	96.9	96.7	96.8
Height, mm	60.9	59.6	60.3	60.3
Length, mm	196.9	196.8	197.0	196.9
Total surface area, m ²	0.0739	0.0731	0.0735	0.0735
Mass loss at 7 cycles, g	0.09	0.05	0.10	0.08
Loss at 7 cycles, g/m ²	1.2	0.7	1.4	1.1
Mass loss at 28 cycles, g	0.14	0.07	0.15	0.12
Loss at 28 cycles, g/m ²	1.9	1.0	2.0	1.6

Notes:

- These results comply with the freeze-thaw resistance requirements of ASTM C 936-12.
- Tests were performed in accordance with ASTM C1645-11.
- The tests were performed in 3% saline solution.

Measures the amount of erosion that occurs as a result of freezing and thawing in a saline solution; measured in # of grams lost of the total surface area (m²).

Paver Finishes, Shapes, & Sizes



Standard Finishes

Many factors come into consideration when choosing the finish for a project—the visual appeal, skid resistance, and the color or pattern of colors used.

Manufacturers offer a number of different textures in standard finishes. The variety of finishes offered in combination with color options makes for an extensive palette. Some examples of standard finishes are shown below, and installations of each finish are presented in subsequent slides.



Standard



Tumbled



Dimpled and Weathered



Split and Aggregate



Flagstone

Standard Finish



Tumbled Finish



Dimpled & Weathered Finish



Split & Aggregate Finish



Flagstone Finish



Advanced Finishes

While the extensive standard selection offered by most manufacturers is often enough to satisfy design requirements, sometimes one needs to create a distinctive look that can only be achieved with an advanced or custom finish solution.

Additional textures and additives can be added to face mix products, adding different aggregates and technologies to the surface to create different effects.

In this section of the course, we review examples of advanced finishes available in stock sizes and colors, as well as in custom colors and sizes.

- Smooth finish
- Washed finish
- Brushed finish
- Random color/aggregate distribution
- Stain-resistant finish: integrally sealed coating for pavers

Smooth Finish

A smooth finish utilizes face mix technology, with finer aggregates on the surface.

The surface appears smooth with a tight finish that will wear extremely well.

Available in a wide range of stock products, this finish can also be customized to create the perfect paver color and style.



Washed Finish

Offering a striking visual effect, washed products are made up of granite and quartz particles.

Washed products are produced via a specialized face mix manufacturing process where the aggregate surface is integrally manufactured with the body of the stone in a single process and not in layers. The resulting surface provides superior long-term wear and structural performance. The final step in its manufacturing process is to wash the concrete from the surface, exposing the beautiful aggregates. As this product ages in its installation, it only looks better.

A washed finish is ideal for a myriad of applications, including driveways, offices, commercial retail plazas, and institutions.

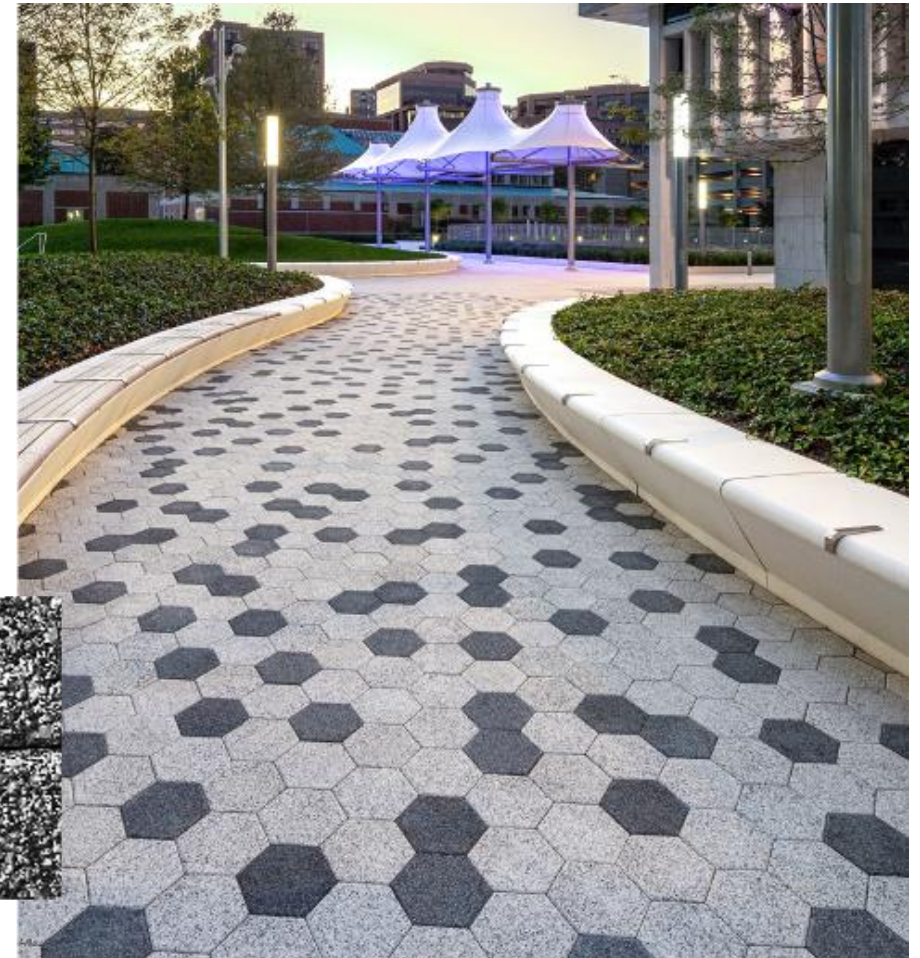

Brushed Finish

Brushed paving stones are made with angular granite in the face mix, which, when brushed, creates irregular lines etched across each paver, delivering an attractive, detailed look.

Available in a variety of dimensionally compatible units, this paving stone system features the ability to create an almost unlimited variety of geometric and random pattern designs.

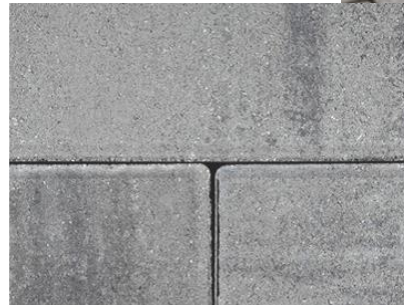

Random Color/Aggregate Distribution

In addition to altering the final texture, other techniques have been developed to create unique finishes, such as the random dispersion of color and aggregates. This type of finish looks like granite but can be customized to create the perfect paver for any design vision.

This finish is combined with an easy-to-clean integral finish (as part of the manufacturing process) that allows for easy cleanup before stains set in.



Integrated Sealed Coating for Pavers

The integrally manufactured coatings of easy-to-clean pavers are dirt repellent, inhibit the growth of algae and moss, reduce chewing gum adherence, and enhance the color on the surface, much like a sealer would. This can be added to many standard pavers to reduce subsequent maintenance. These photos are of a train station in Germany designed with easy-to-clean pavers.



Note how dirty the pavers are, particularly under the seats.



Pavers are simply power washed with soap and water.



After cleaning, pavers look brand new.

Shape: Design Considerations

It is important to understand the application requirements in order to select a paving solution best suited to the project.

Considerations include:

- Is the paved area subjected to vehicular or pedestrian traffic?
- Are heavy-duty or light-duty pavers required?
- Do pavers need to be permeable or nonpermeable?
- Will the pavers be installed on-grade or on a roof deck?
- What is the look and feel of the project?

The answers to these questions will help determine what paver shape/size is ideal for your project.



Shapes Available

An extensive line of product shapes is available in the North American market, although all shapes may not be available in all finishes.

SLABS

$23\frac{1}{2} \times 23\frac{1}{2} \times 2$ (60 x 60cm) T: 5cm	$23\frac{1}{2} \times 23\frac{1}{2}$ " (60.6 x 60.6cm) T: 5cm	$17\frac{1}{2} \times 23\frac{1}{2}$ " (45.3 x 60.6cm) T: 5cm	$11\frac{1}{2} \times 23\frac{1}{2}$ " (30.1 x 60.6cm) T: 5cm	$11\frac{1}{2} \times 23\frac{1}{2}$ (30 x 60cm) T: 5cm
---	--	--	--	--

SQUARES







36×36 " (90 x 90cm) T: 10cm	24×24 " (60 x 60cm) T: 5, 7 or 10cm	16×16 " (40 x 40cm) T: 7, 8 or 10cm	12×12 " (30 x 30cm) T: 7, 8 or 10cm	8×8 " (20 x 20cm) T: 7, 8 or 10cm	6×6 " (15 x 15cm) T: 7 or 8cm	4×4 " (10 x 10cm) T: 7cm
---	---	---	---	---	---	--------------------------------------

RECTANGLES

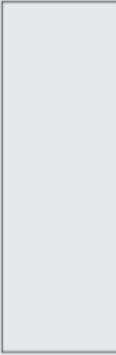

18×36 " (45 x 90cm) T: 10cm	16×24 " (40 x 60cm) T: 10cm	12×24 " (30 x 60cm) T: 5, 7, 10 or 15cm	12×18 " (30 x 45cm) T: 10cm	8×16 " (20 x 40cm) T: 7 or 10cm	7×14 " (18 x 36cm) T: 6 or 8cm	6×12 " (15 x 30cm) T: 7, 8 or 10cm	5×10 " (12 x 24cm) T: 8cm	6×8 " (15 x 20cm) T: 7cm	4×8 " (10 x 20cm) T: 6, 7 or 8cm	3×6 " (7.5 x 15cm) T: 10cm
---	---	---	---	---	--	--	---------------------------------------	--------------------------------------	--	--

Shapes Available in the North American Market

PLANKS

						
12 x 36" (30 x 90cm) T: 10cm	8 x 24" (20 x 60cm) T: 10 or 15cm	6 x 24" (15 x 60cm) T: 7 or 15cm	4 x 16" (10 x 40cm) T: 10cm	4 x 12" (10 x 30cm) T: 7, 8 or 10cm	3 x 12" (7.5 x 30cm) T: 10cm	2 x 9" (6 x 24cm) T: 7cm

GEOMETRICS

			
8 x 8" (20 x 20cm) T: 7cm	10 1/4 x 10 1/4" (26 x 26cm) T: 8cm	6x12x16 1/2" (15x30x42.4cm) T: 7 or 8cm	8 7/8 x 5 1/2" (14.7 x 22.4cm) T: 8cm

Permeable Applications

Rainwater infiltration is extremely important, not only to the groundwater supply and maintaining the health of our rivers, streams, and wetlands, but also to prevent flooding. A permeable paver surface is capable of handling more than 100" (2,540 mm) of rainwater per hour. These systems above porous soils allow for maximum infiltration. Even clay subsoils will allow for some infiltration. The paver joints must be maintained to allow for maximum infiltration.

No longer do you need to compromise style for function. The range of permeable paver styles available today is greater than ever before—rectangular, square, linear, hexagonal, with almost any finish and color to complement your design. And if you still need more options, regular pavers can be installed with permeable spacers.

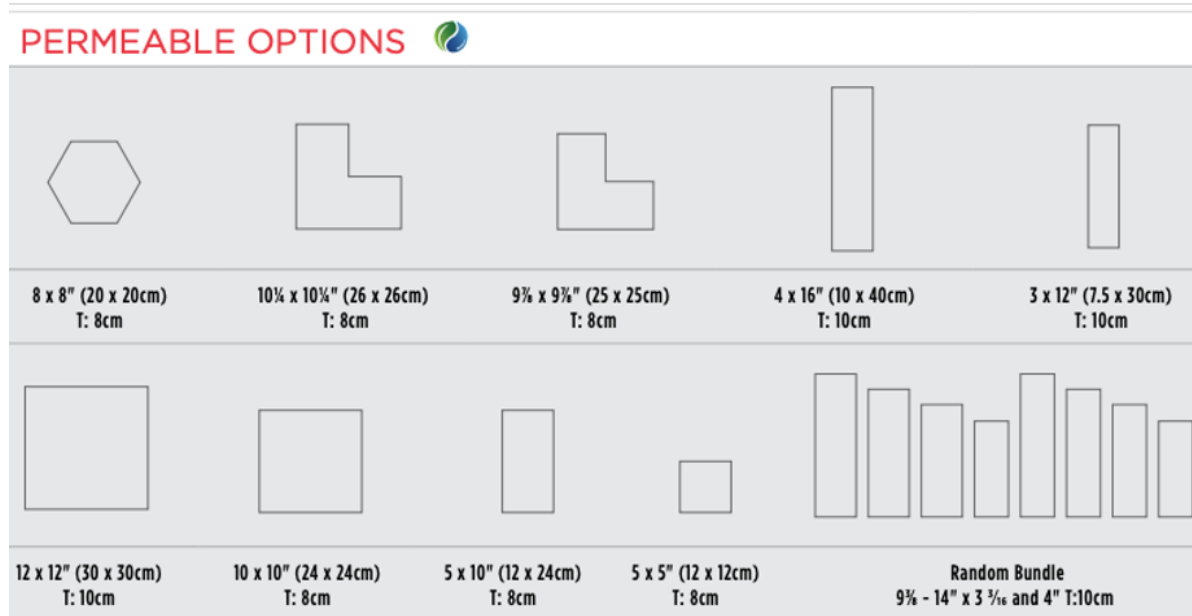

Heavy-Duty Vehicular Applications

Heavy-duty pavers designed for rapid mechanized installation are also available. Providing a stronger, more stable pavement surface, these pavers feature an “L” interlocking shape that offers superior resistance to tipping and twisting. Heavy-duty paving stones can withstand the heaviest vehicular loads.

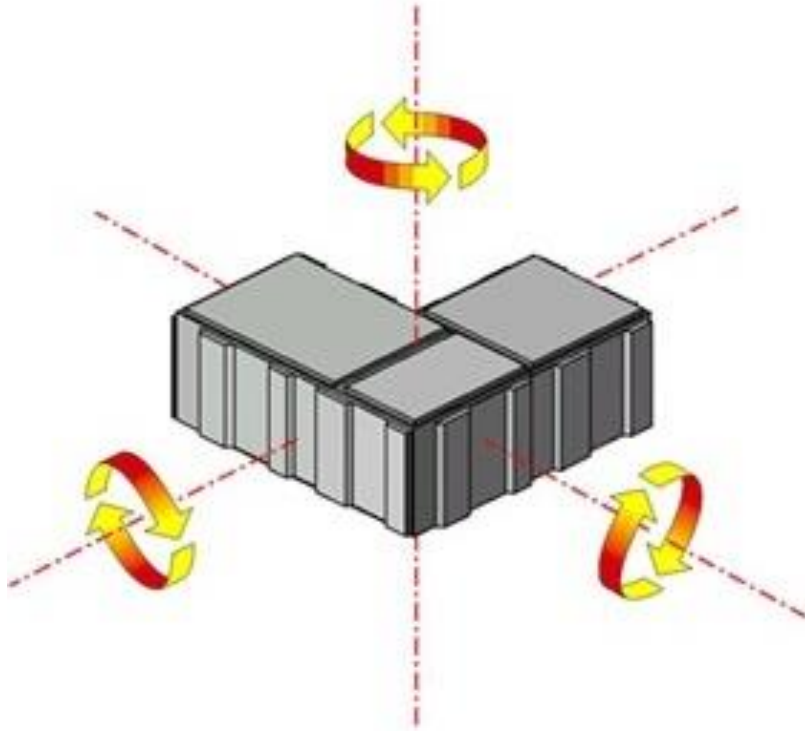

Roof Deck Applications

Amenity roof deck spaces are essential to today's urban developments. They can incorporate patios, dining and bar areas, putting greens, pools, garden spaces, grilling areas, and more.

Today's pavers and architectural slabs provide an extensive selection of styles and finishes to complete these rooftop designs.

Typical installations include on pedestals, on a granular base, and on a permeable base. Although these three are the most commonly used, there are additional methods including mortar set or sand over concrete, rigid insulation, and self-leveling concrete that can be used in the appropriate applications.



Custom Paving Options

Custom shapes are available from some manufacturers to accommodate unique design requirements. Along with custom shapes, most manufacturers offer a variety of standard colors as well as custom colors and custom finishes; typically, a minimum order requirement will apply.

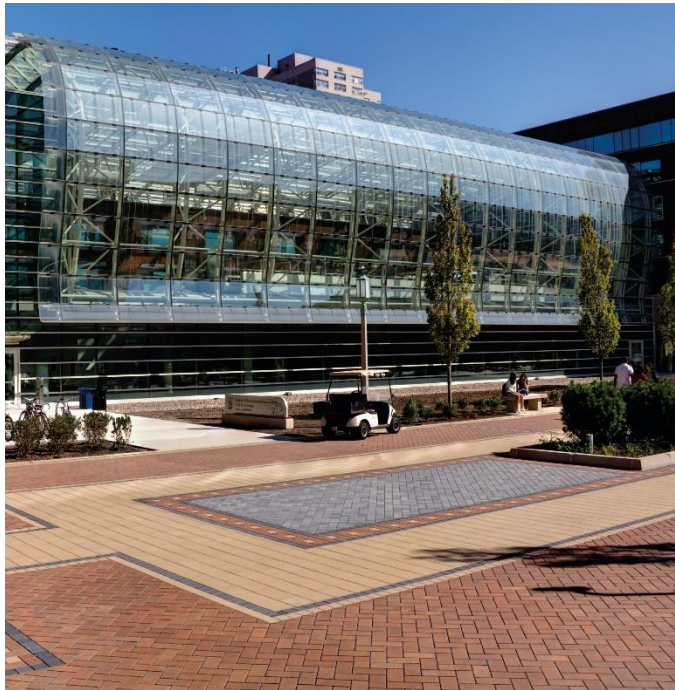

Custom colors for permeable pavers at Loyola University (Chicago, IL)



Custom color and shapes created for Navy Pier, with 30% recycled content (Chicago, IL)

Technical Assistance

To facilitate the design process, it is recommended to work with a manufacturer early in the design stages to achieve the desired aesthetic while maintaining feasibility and understanding any technical hurdles.

Some manufacturers have a full CAD and SketchUp library of their products, providing 3D design to aid in the planning process.

Many manufacturers will also be able to provide product details, specifications, and cross sections to help you build out your documents and drawings.

When choosing architectural paving products, it's important to look for a manufacturer that has proven industry expertise and is readily available for collaboration to ensure that every intricate detail of your project runs smoothly.

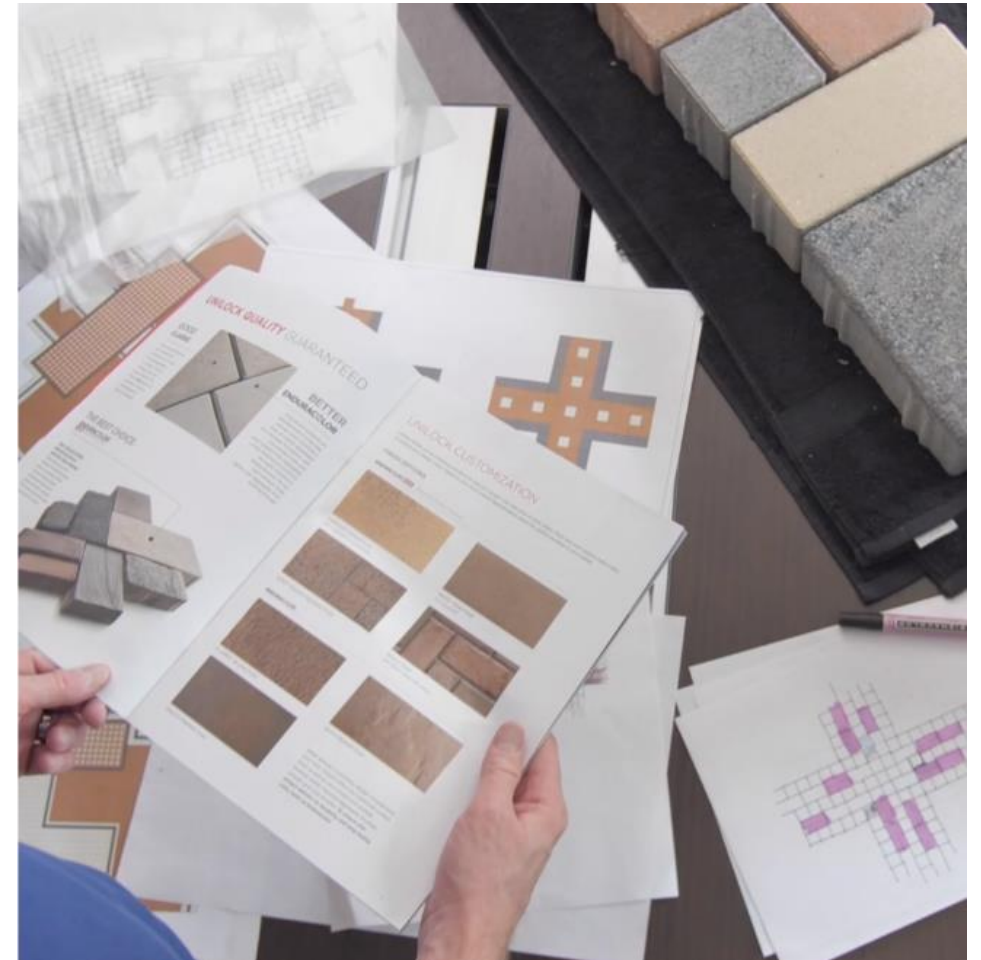

Review Question

What are the factors one must consider when determining the most suitable paver shape/size for a project?

Answer

What are the factors one must take into consideration in determining the most suitable paver shape/size for a project?

Considerations include:

- Is the paved area subjected to vehicular or pedestrian traffic?
- Are heavy-duty or light-duty pavers required?
- Do pavers need to be permeable or nonpermeable?
- Will the pavers be installed on-grade or on a roof deck?
- What is the look and feel of the project?

Architectural Paving Projects



Striking Streetscape Design with Dry Cast Pavers



Project: Dundas Place, London, ON
Designer: Dillon Consulting

This project was designed with dry cast pavers manufactured with face mix technology.

The selected high-performance, exposed granite finish creates a slip-resistant surface that meets the function, utility, and operational needs of a wide range of road users while creating this striking visual effect.

Timeworn Beauty with Wet Cast Pavers



Project: Western Reserve Historical Society of Cleveland, Cleveland, OH

Designer: AECOM

This project was designed with wet cast pavers manufactured with technology that delivers up to four times the strength of conventional poured-in-place concrete.

Timeworn Beauty with Wet Cast Pavers

The chosen pavers were manufactured using flexible polyurethane molds that were cast from actual stones in order to create a more realistic looking product that resembles European street pavers.



Dynamic Design with Permeable Pavers



Project: Harrison PATH Station,
Harrison, NJ

Designer: Port Authority of New York &
New Jersey

This project was designed with permeable pavers manufactured with face mix technology and spacer bars that allow for maximum water infiltration, perfect for reducing stormwater runoff.

The availability of color options in this durable exposed granite finish (ideal for high-traffic pedestrian spaces) also allowed the designer to create a visually dynamic paving pattern that plays off the modern style of the building.

Strong & Stable Surface with Heavy-Duty Pavers



Project: E.L. Harvey & Sons,
Westborough, MA

Designer: Hayden Construction &
Utilities

Focused on achieving a strong and more stable pavement surface, this project was designed with a heavy-duty, L-shaped paver, utilizing tri-axis locking technology to provide superior resistance to large, heavy, and turning loads.

Rooftop Amenity Space with Architectural Slabs

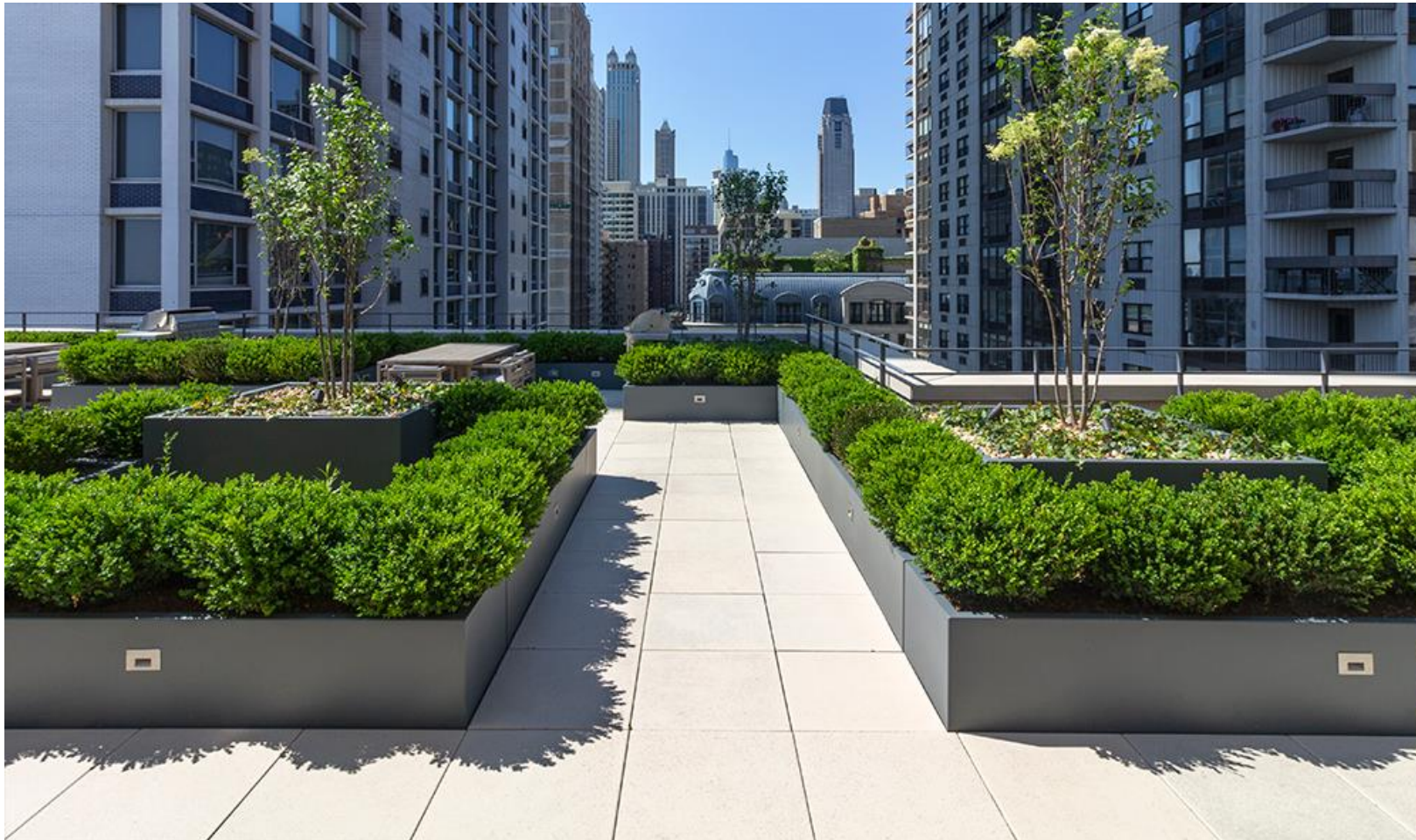

Project: 61 E Banks Roof Deck, Chicago, IL

Designer: Jacobs/Ryan Associates

This roof deck was designed with sleek and modern architectural slabs that were manufactured using granite, quartz, and marble, which provide a durable and nonslip surface. The surface was further enhanced with a built-in sealed coating that ensures ease of maintenance, perfect for this amenity space.

Rooftop Amenity Space with Architectural Slabs



The selected slabs are also 24" x 24" in size with smooth, clean lines, making them the ideal product for this pedestal installation.



Part 2: Segmental Retaining Walls (SRWs)

Introduction to SRWs

Retaining walls are strong, durable, vertical fronts that are used in applications such as these:

- Strengthening steep slopes in grade changes
- Holding back soil to prevent it from slumping
- Creating flat, usable space that would otherwise be unusable because of the lay of the land
- Serving as bridge abutments
- Containing and directing stormwater
- Protecting waterfronts

Retaining walls may look like simple structures, but in fact, they are carefully engineered wall systems that are complex to design, construct, and inspect. Poor retaining wall design poses serious safety hazards to people and property.

Retaining Wall Design

In most US states, retaining wall designs taller than about 4 feet must be designed by or approved by a qualified, licensed professional engineer. In Canada, retaining wall designs taller than 1 meter require a professional engineer's approval.

It is important to check with and adhere to local building codes prior to any construction, even when walls are shorter than 4 feet or 1 meter, as local building code height restrictions can be different. A noncompliant retaining wall may collapse after a heavy rain event, after erosion undermines the base of the wall, or because the loads behind or on top of the wall are too heavy.

While retaining walls can be aesthetically pleasing hardscape features, they are load-bearing wall systems that must provide structural, external, internal, and facial stability.



Retaining Wall Design

If a retaining wall project does not require engineering, a design and construction team should follow the segmental retaining wall installation guidelines and recommendations of individual manufacturers. Their proprietary wall designs utilize specific product lines, and substitution of any material or concrete block is not recommended.



Retaining Walls

Many different materials or a combination of materials are used to construct retaining walls, including brick, poured concrete, steel, wood, concrete block, and stone veneer. The building technique or type of wall selected may depend on many factors, including the application and location (commercial, residential, industrial), wall height, structural requirements, and soil conditions.

A professional engineer will:

- evaluate a site's stability (slope, soil, rock, etc.)
- determine the location, size, and type of retaining wall required to meet the structural requirements of the application
- determine whether soil reinforcement is required
- advise on the selection of materials
- design the wall and provide drawings
- provide specifications for the wall's construction
- monitor the construction process, and
- inspect the wall.

What Is a Segmental Retaining Wall (SRW)?

Segmental retaining walls (SRWs) are constructed of manufactured concrete modular blocks that are uniform in weight and dimensional tolerances. The blocks are dry stacked (no mortar) and placed by either hand or machine.

Since the blocks in these mortarless walls must not slide, they may be interlocked using pins or clips or a tongue-and-groove or rear lip molded into the blocks themselves.



What Is a Segmental Retaining Wall (SRW)?

SRWs are designed as conventional **gravity retaining walls** or **reinforced soil retaining walls**. The type specified commonly depends on the height of the wall being constructed, but there are applications where it is necessary to reinforce the wall regardless of its height—for example, when the wall has surcharges or slopes, or it is on difficult foundation soils.

Most block manufacturers offer assistance in determining the maximum height a retaining wall can be built to before reinforcement is required.

Gravity Retaining Wall

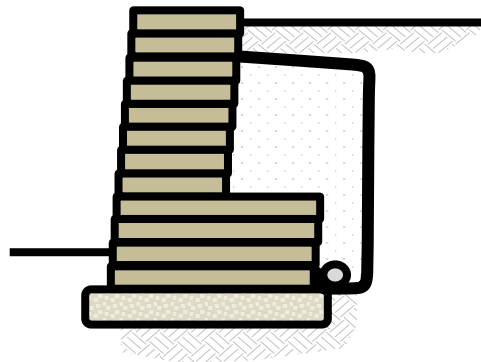

Reinforced Soil Retaining Wall

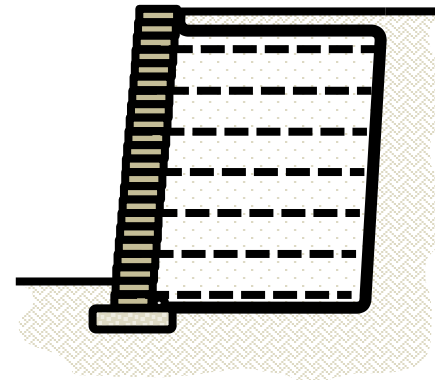

Common SRW Terminology

Backfill Soil: Soil material placed and compacted around the geogrids. Ideally, free-draining granular material.

Base Course: The first row of blocks placed on top of the base. This unit or block is at or below grade. Some walls may have more than one course of blocks below grade.

Batter: Apparent inclinations of the retaining wall face due to the units' setback, measure from vertical.

Compaction: The process of reducing the voids in newly placed soils by vibration, kneading, or tamping to ensure the maximum density and strength of the soil.

Coping: The top course of units in the wall. Provides a finished appearance and ties the wall together.

Dimensional Tolerance: SRWs are designed to be flexible structures that can tolerate deviations from construction drawing alignments. Established construction tolerances (e.g., variation in horizontal and vertical control [alignment], variation in wall rotation, and variation in settlement) cannot affect the stability of the SRW. The alignment of an SRW can often be corrected or modified during construction.

Common SRW Terminology

Fascia/Facing: The assembled modular concrete units that form the exterior face of the retaining wall.

Filter Cloth: A continuous sheet of flexible, permeable fabric used to separate, filtrate, and reinforce.

Proctor or Standard Proctor Density (SPD): The determination process for the moisture–density relationship in compacted soils. Generally, 95% is the goal.

Shoring: Temporary support to relieve the loads on an SRW while it is constructed, reinforced, or repaired.

Surcharge: Loads or extra weight placed on the soil above and behind the retaining wall.

Wall Embedment: Depth of retaining wall that is buried. Distance from top of base to lower surface grade.

Manufacturing Standards: ASTM

The structural integrity and performance of segmental retaining wall units is ensured by manufacturing to specifications that meet or exceed ASTM standards.

Several factors contribute to a durable and quality segmental retaining wall product, including these ASTM C1372 factors:

- **Compressive strength:** no individual unit less than 2,500 psi
- **Water absorption:** no individual unit greater than 10.5%
- **Dimensional tolerances:** length, width, or height $\pm \frac{1}{8}$ " (3.2 mm)

Manufacturing Standards: NCMA

The NCMA (National Concrete Masonry Association) is a trade organization that was originally formed to support the concrete masonry and building block industry. As many of the masonry block producers started manufacturing SRWs, the NCMA evolved to incorporate them into their scope. The NCMA now acts as the primary industry body for SRW research, best practices, and design methodologies and is a great resource for information.

There are technical standards set by the NCMA regarding Zone 3 deicing salt exposure to further determine the durability of an SRW unit (shown on the right).

Exposure Zone	Required SRW Properties
Zone 3 Deicing salt exposure	ASTM C1372, plus <ul style="list-style-type: none"> Targeted compressive strength: 5,500 psi Targeted absorption: 7 lb/ft³

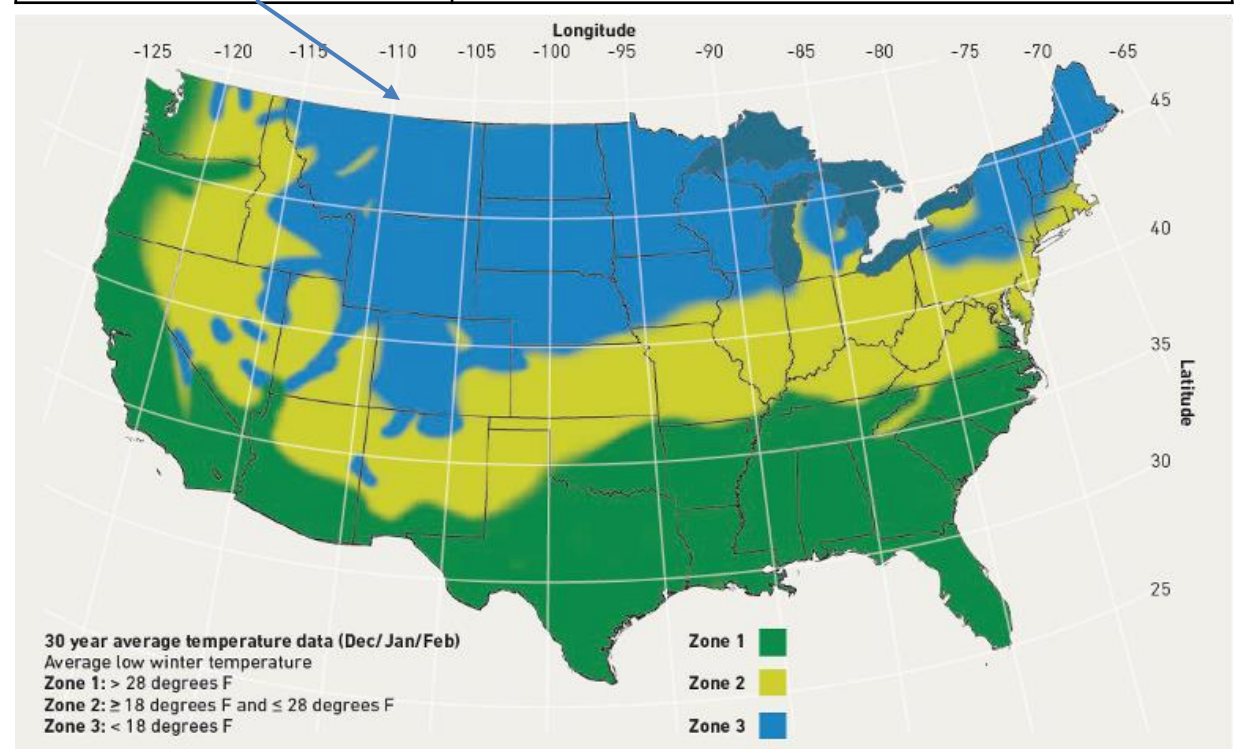

Types of SRW Construction



Types of SRW Construction

There are two main types of SRW construction:

1. Gravity Wall

In simplest terms, this type of construction relies on the mass (weight) of the units to resist lateral earth pressures.

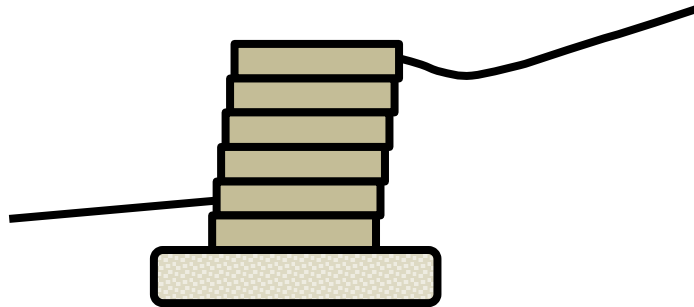

2. Geogrid-Reinforced Wall

This type of construction is made up of SRW units, a mesh-like reinforcement material, and backfill soil to create one composite mass that resists lateral earth pressures.

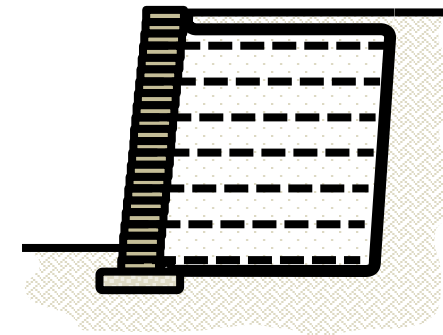

Gravity Walls

An SRW is essentially a type of gravity wall that creates a mass through the weight of the SRW units themselves.

There are three types of gravity walls:

Single-Depth Gravity Wall

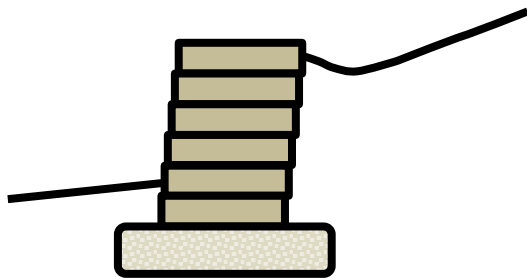

Multidepth Gravity Wall

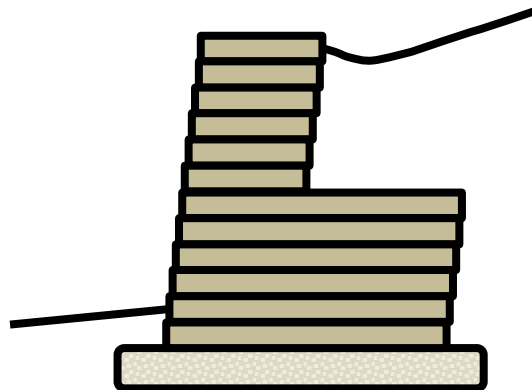

Crib Gravity Wall

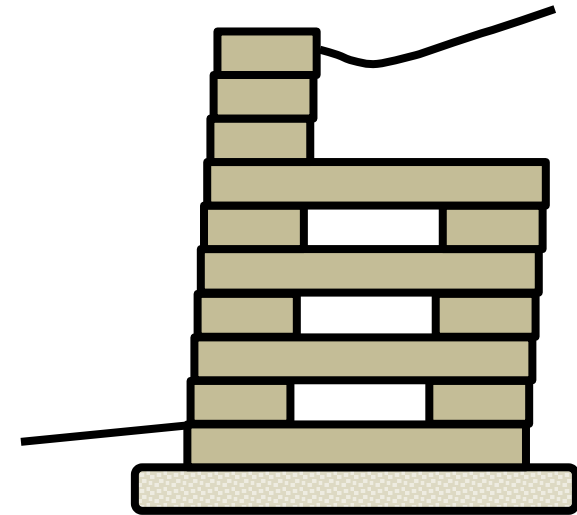

Single-Depth Gravity Wall

In its simplest form, SRW units are stacked on a gravel base with a drainage layer behind them. It is called a single-depth gravity wall because all the units have the same front-to-back depth.

The mass from the SRW units creates a friction force along the base, which resists the lateral earth pressure from the adjacent soil and prevents sliding and overturning.

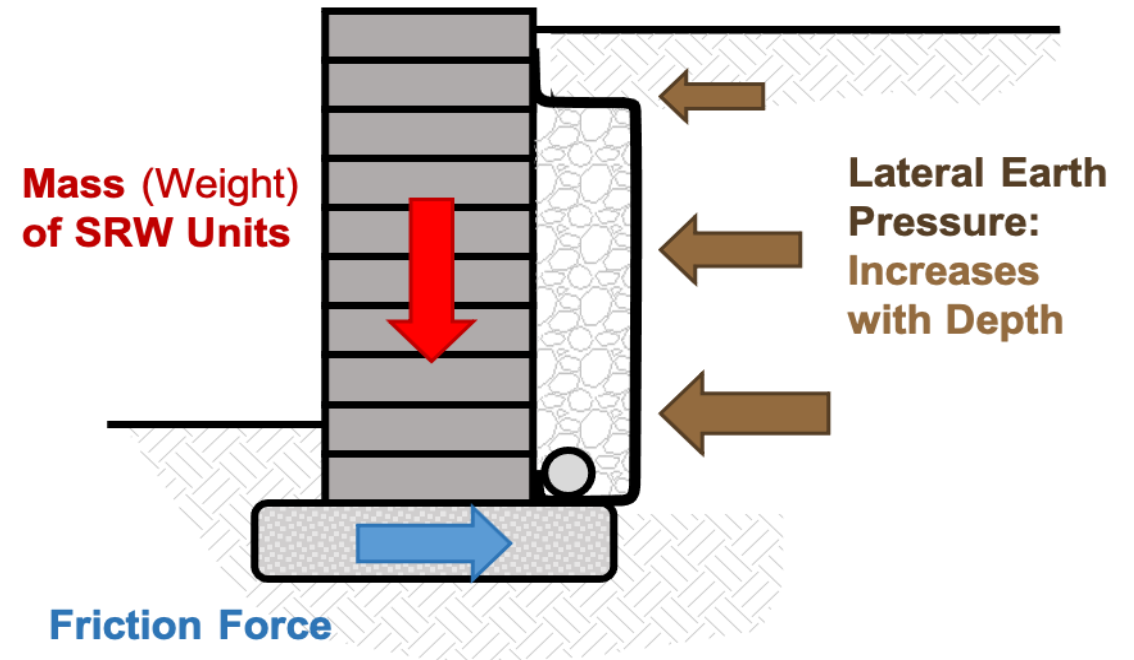

Single-Depth Gravity Wall

Since you are relying only on the weight of the SRW units, the critical dimension of the wall is the depth, shown as (D), which gives the wall its mass.

The depth of the block (D), can relate to the height of the wall (H) with a rule-of-thumb ratio of $D = (30\text{--}50\%)$ of H. As the wall gets higher, the depth of the wall (or wall mass) is required to be greater, since earth pressure increases with height.

This ratio can vary based on a few factors. As earth pressure increases, the depth of the wall must also increase. These factors include:

- slopes above the wall; the steeper the slope the more pressure is exerted on the wall
- the quality of soil being retained; for example, high-quality gravel will exert less force than clay, and
- the presence of surcharges—for example, traffic load or house footing.

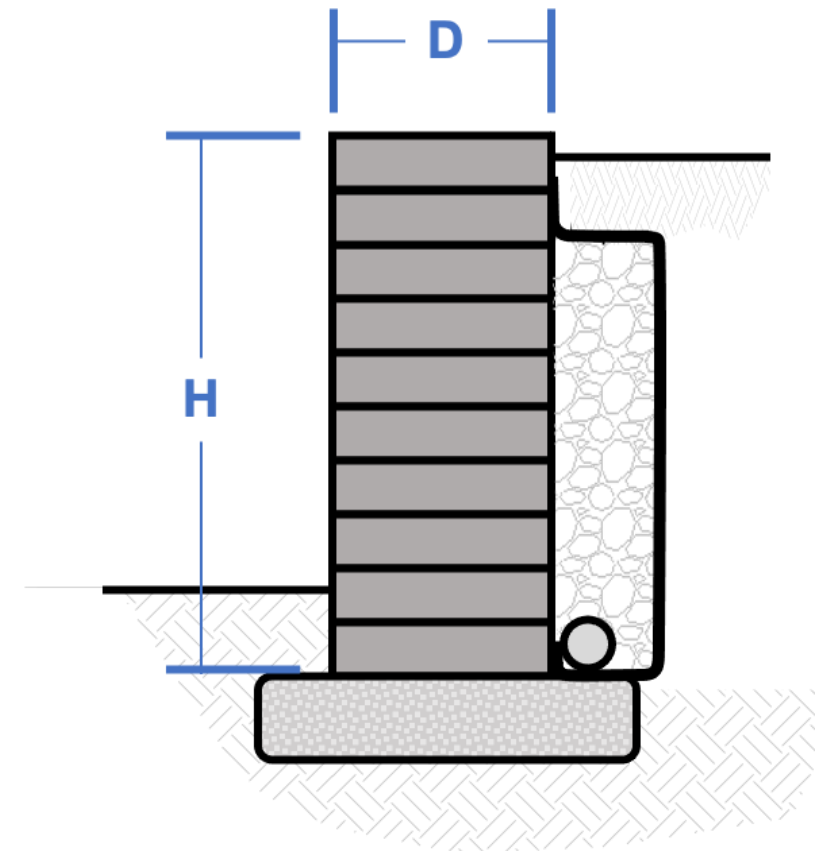

$$D = (30\text{--}50\%) \text{ of } H$$

Single-Depth Gravity Wall: Cross Section

TYPICAL SECTION - NOT FOR CONSTRUCTION

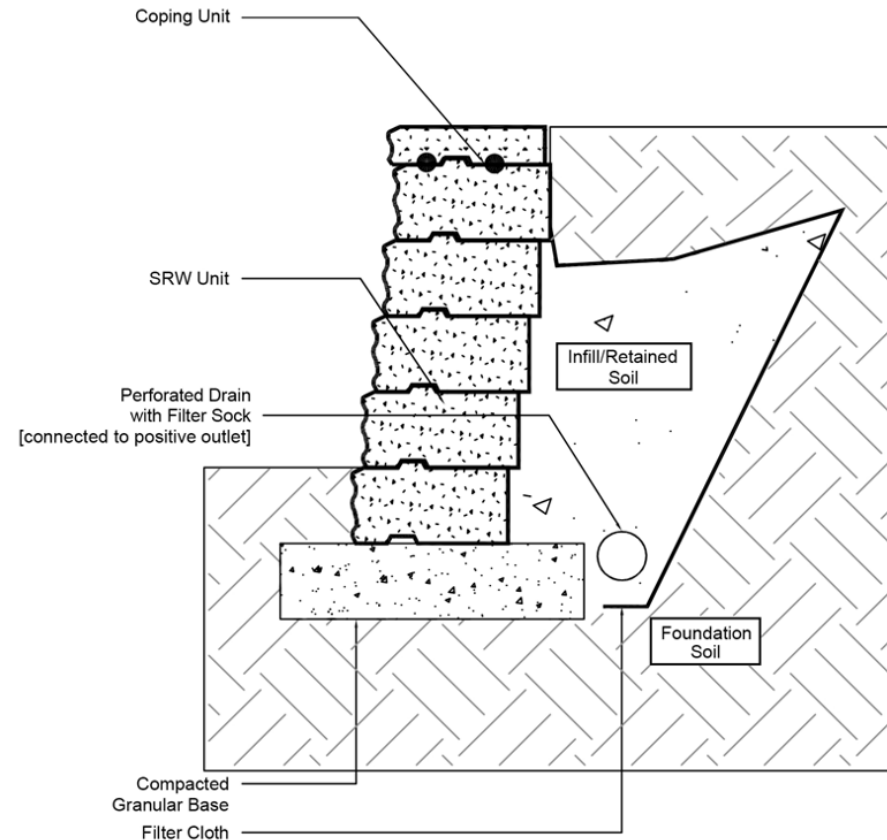

Remember: It is important to connect with block manufacturers or engineers who can assist in determining the maximum height of a retaining wall based on existing soil conditions before extra reinforcement is required.

Multidepth Gravity Wall

As you build higher, you need to increase block depth. However, earth pressure decreases as you get closer to the top of the wall. This allows for the creation of a multidepth gravity wall, where the depth of the block decreases as you near the top of the wall because the pressure in this area is less. This creates a more economical gravity wall, as mass is only being put where it is needed.

This wall utilizes SRW units of different depths and incorporates the drainage backfill as part of the weight of the wall to create a composite mass.

The drainage backfill sits on top of the lower units, so it works to create part of the wall mass, giving the wall the equivalent depth (D) as shown in the diagram.

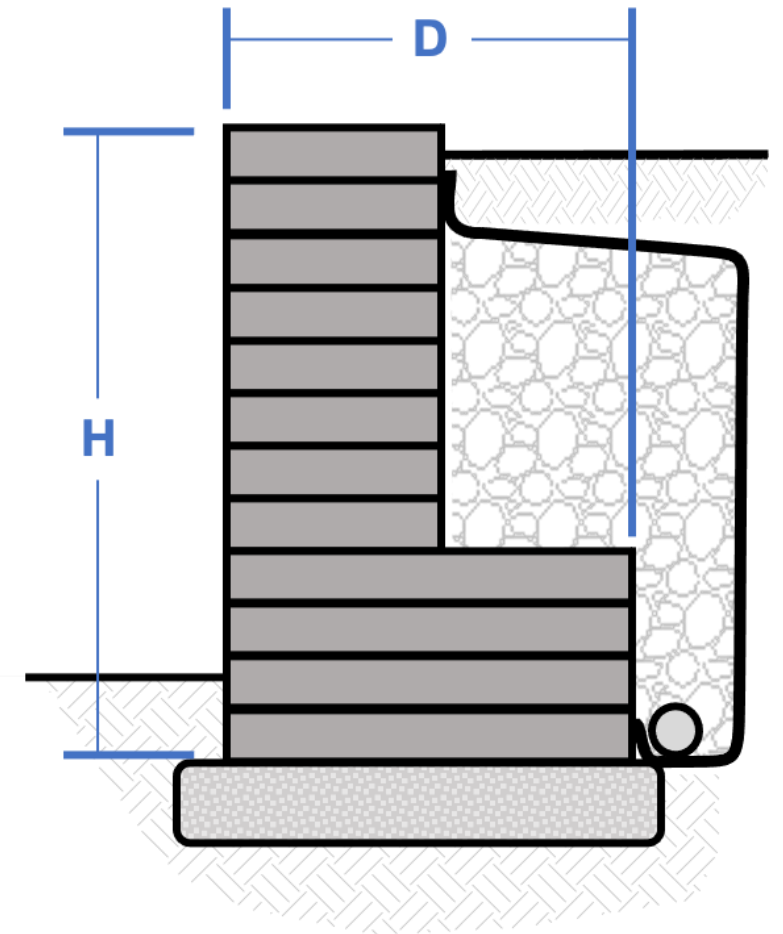

Multidepth Gravity Wall

Generally, local municipalities do not allow part of a retaining structure to extend over any property line. Therefore, in cases where a geogrid-reinforced wall cannot be used due to space limitations, but a higher depth-to-height ratio is still required, a multidepth gravity wall may be used.

This type of construction saves room and allows the wall to move closer to the property line. However, this does not account for excavation requirements. Should excavation not be allowed over the property line, then temporary shoring may be required.

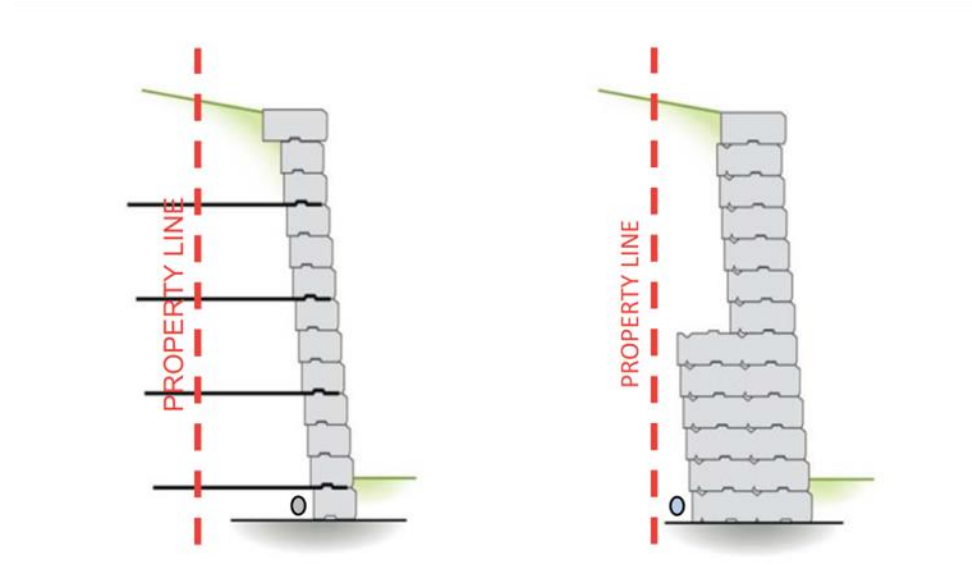

Multidepth Gravity Wall: Cross Section

TYPICAL SECTION - NOT FOR CONSTRUCTION

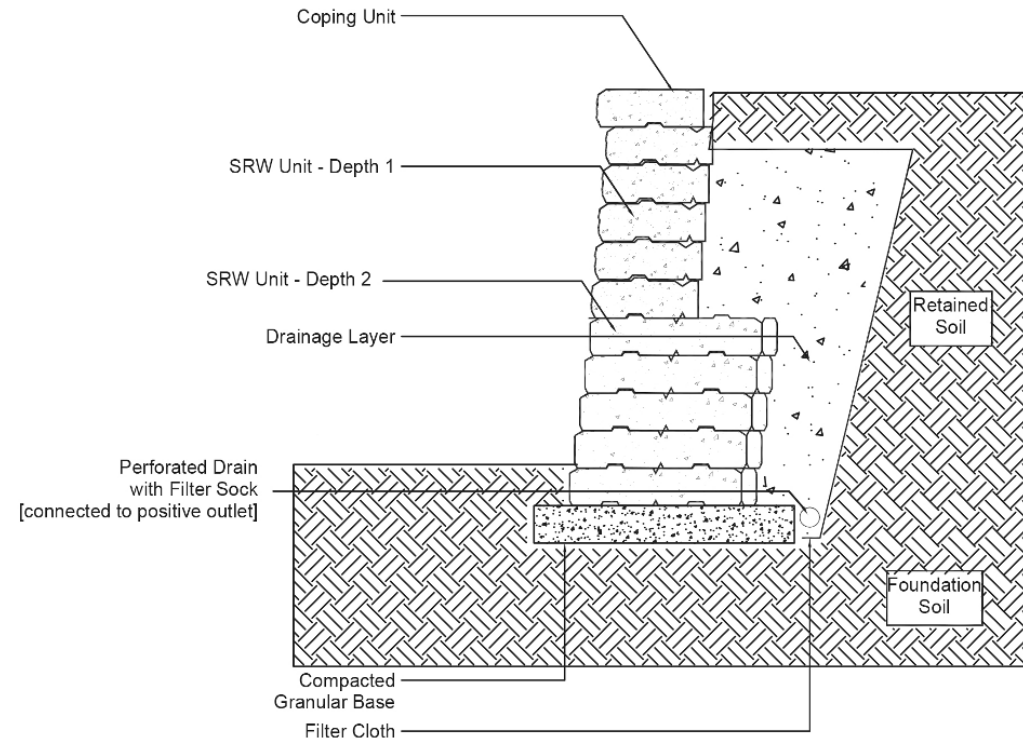

Remember: Contact block manufacturers and engineers to determine the maximum height of a retaining wall based on existing soil conditions for a gravity wall design.

Crib Gravity Wall

This wall is a combination of tie-back units and dead-man units that join the facing to create a massive crib structure.

The crib is then filled with drainage aggregate for weight to create a composite mass.

Typically, this is the most expensive SRW; however, it can be ideal for situations where very high walls (10'–30') are required and the space to build them is limited.

Although the cost can be higher for this type of wall, it is still more economical than reinforced concrete or soldier pile walls.

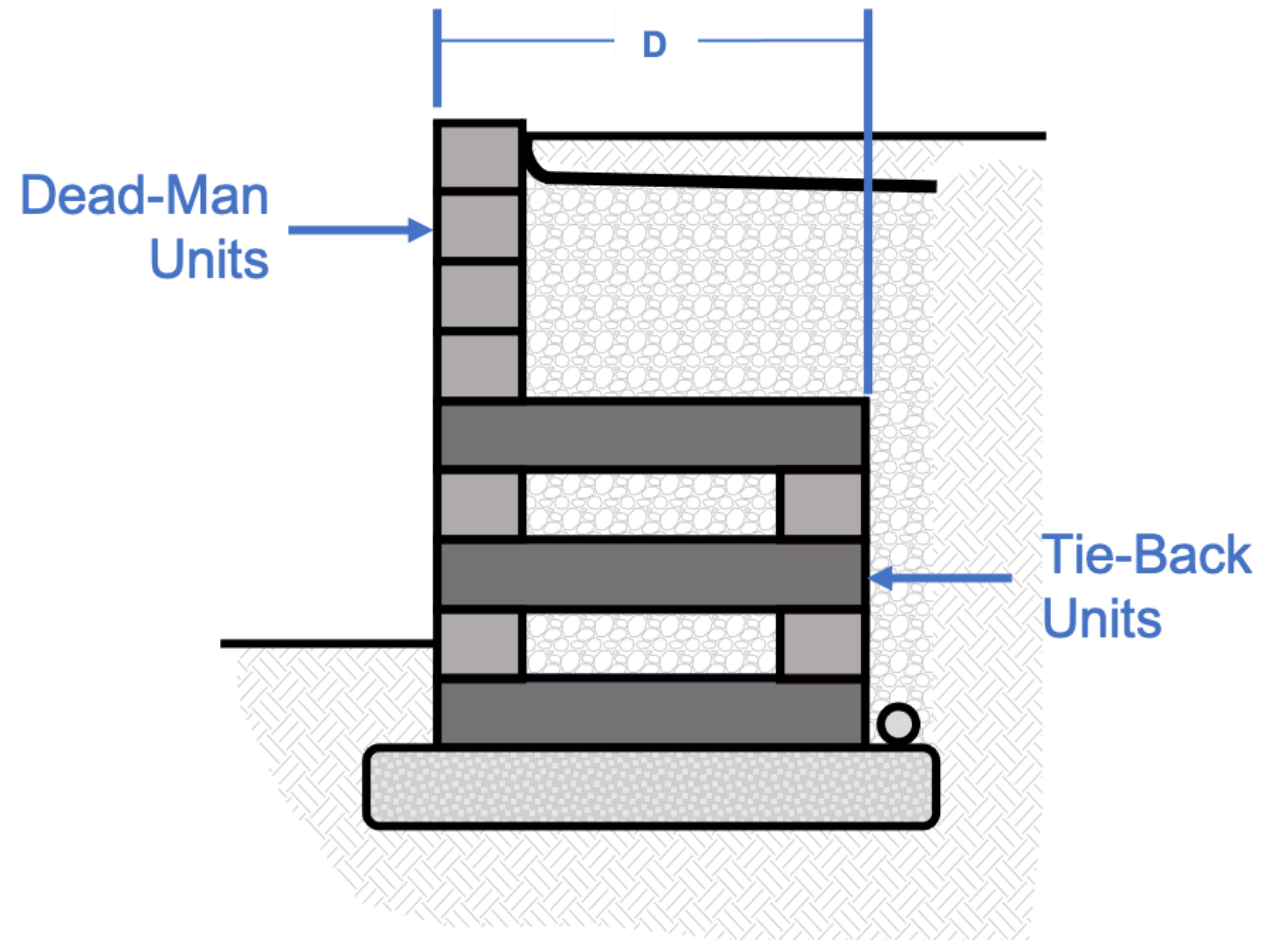

Crib Gravity Wall: Cross Section

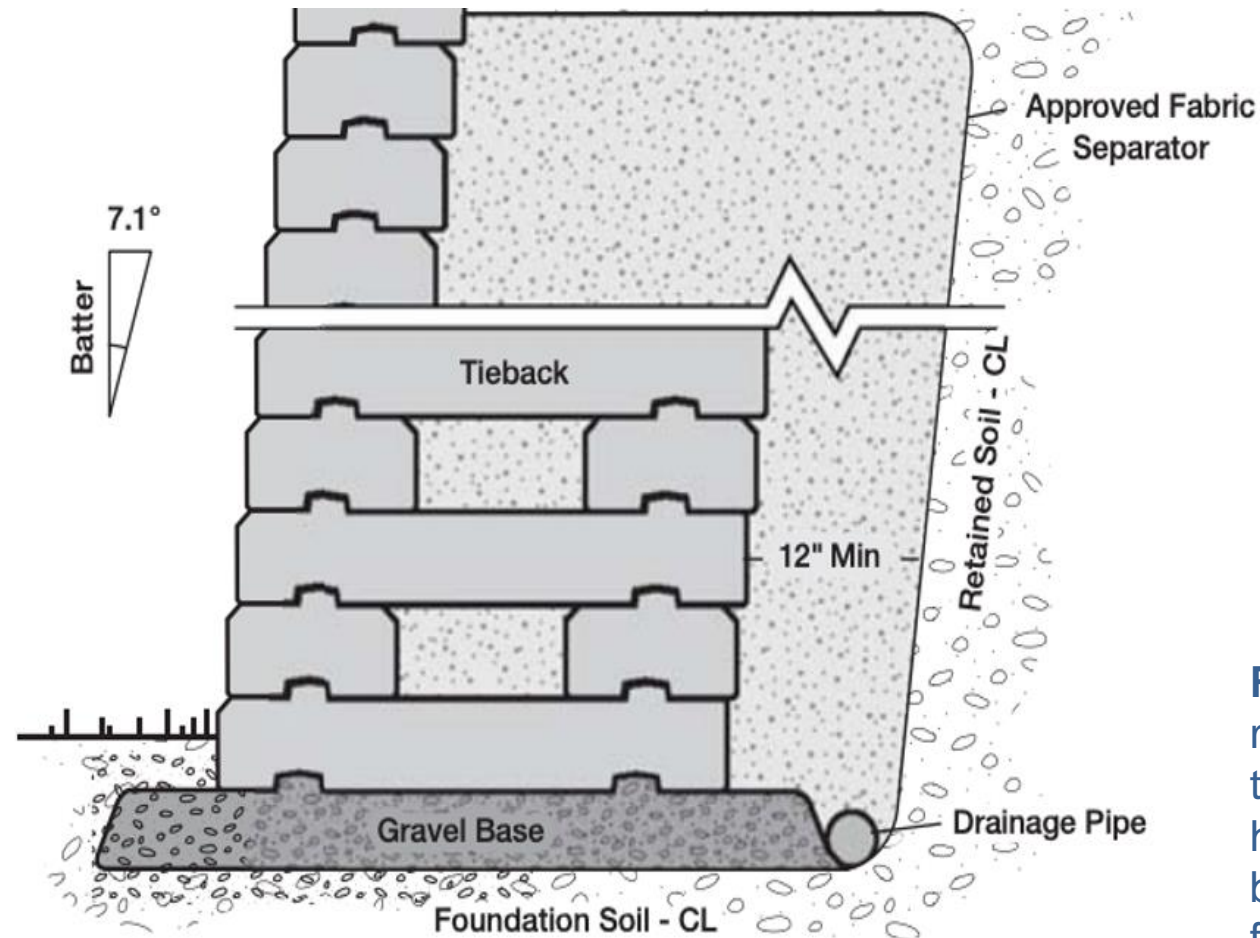

Remember: Contact block manufacturers and engineers to determine the maximum height of a retaining wall based on existing conditions for a gravity wall design.

Geogrid-Reinforced Walls

The geogrid-reinforced SRW is the most innovative and economical method of constructing higher walls.

What is geogrid reinforcement?

- It is a mesh-like sheet product used to reinforce and stabilize soil. Geogrids also serve to support separation, drainage, filtration, and erosion control.
- Geogrid is very strong in tension and acts like reinforcing steel in concrete, providing the tensile resistance needed to keep the soil mass together.
- Geogrid sheets are placed between the layers of blocks at specific heights and extend into the soil behind for specified lengths to facilitate reinforcement.

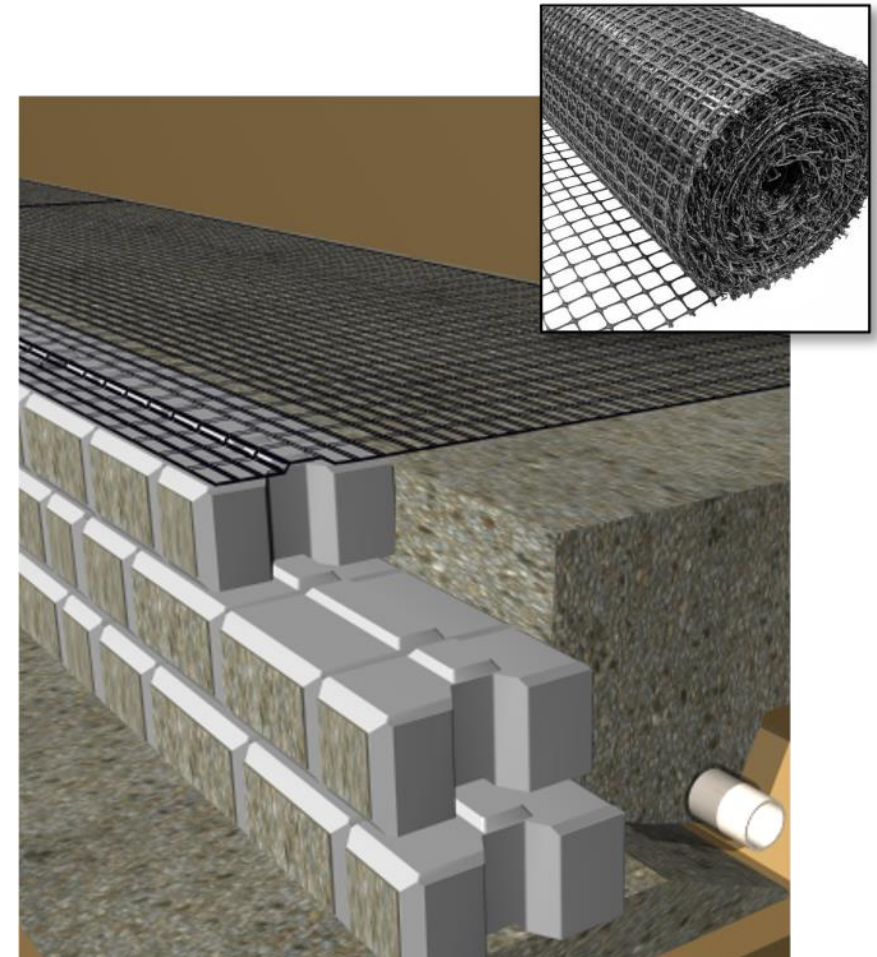

Geogrid-Reinforced Walls

A geogrid-reinforced SRW is essentially a large gravity wall composed of:

- SRW facing units
- backfill soil, and
- geogrid reinforcements.

These elements combine to create a composite mass.

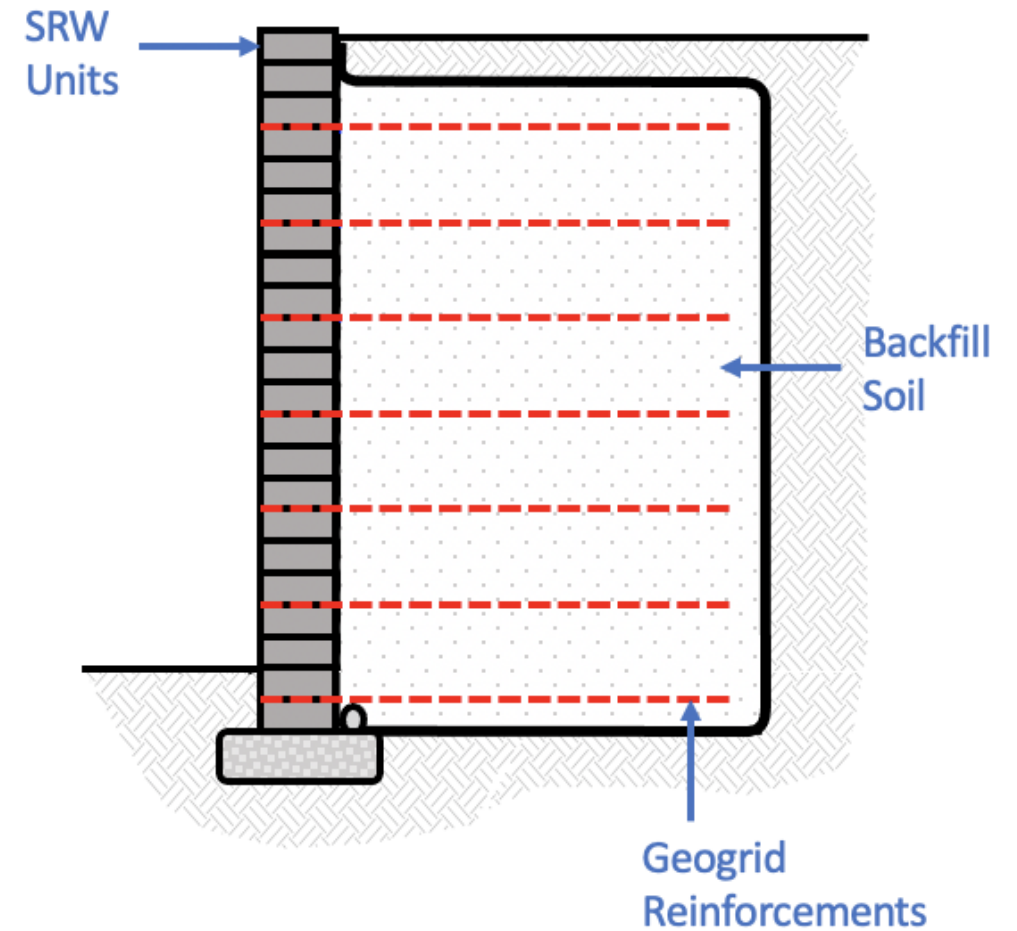

Geogrid-Reinforced Walls

Like gravity walls, the depth (D) of the wall is created by the length of the geogrid reinforcement.

Typically, the length of reinforcement is between 60 and 70% of the height of the wall (H). However, this does not account for poor soil conditions, slopes, surcharges, or the impact of seismic loading. For preliminary purposes, a higher ratio (70–80%) will allow for some of these conditions.

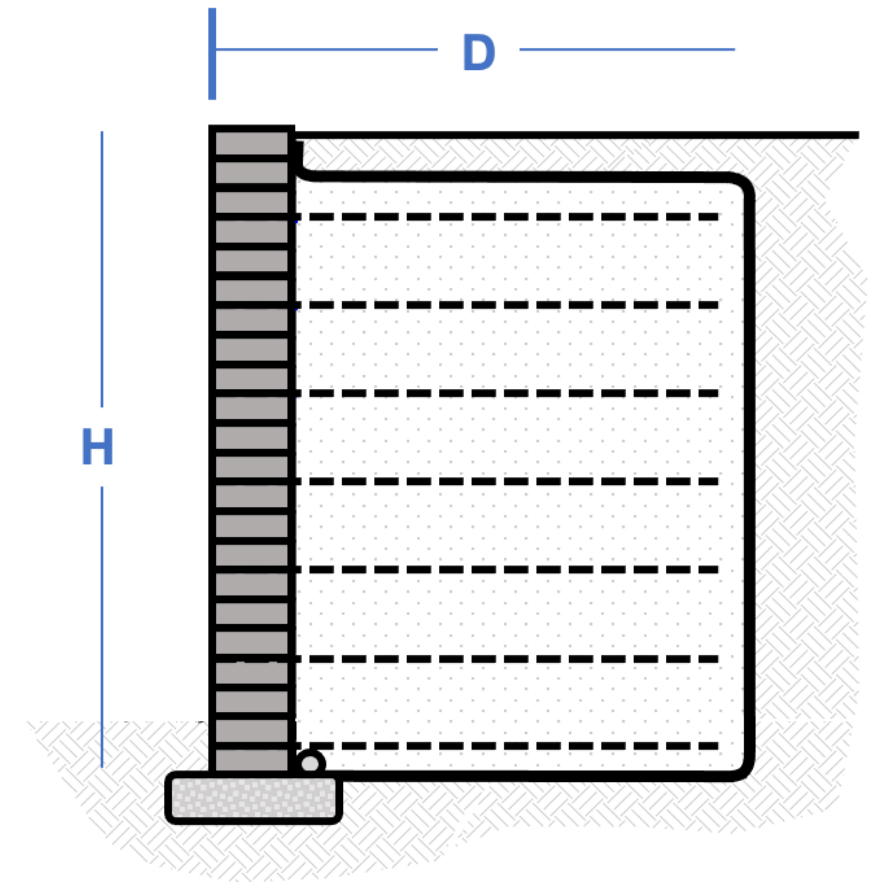

$$D = (60-70\%) \text{ of } H$$

Geogrid-Reinforced Wall: Cross Section

TYPICAL SECTION - NOT FOR CONSTRUCTION

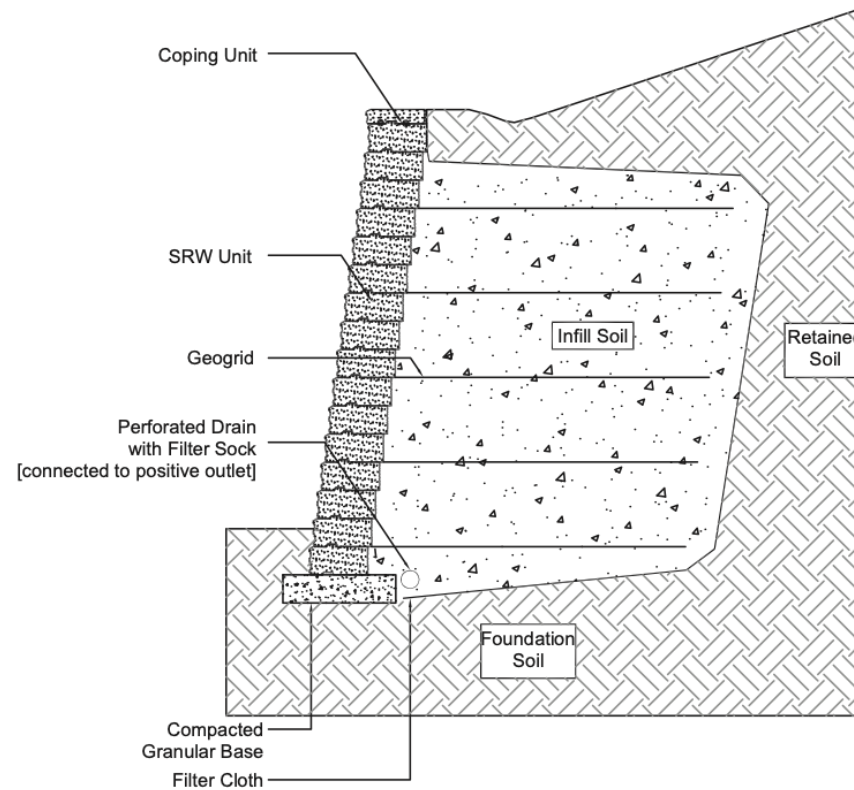

Remember: Excavation cannot encroach property line.

Review Question

What are the three factors that contribute to the manufacturing of a durable and quality SRW product?

Answer

What are the three factors that contribute to the manufacturing of a durable and quality SRW product?

Per ASTM C1372:

- Compressive strength: no individual unit less than 2,500 psi
- Water absorption: no individual unit greater than 10.5%
- Dimensional tolerances: length, width, or height $\pm \frac{1}{8}$ " (3.2 mm)

SRWs Available in the North American Market



Segmental Retaining Wall Options

The type of segmental retaining wall product that is used for a project will vary based on the application and type of construction.

It is important to work with a manufacturer early in the design stages to achieve the desired aesthetic while maintaining feasibility, durability, and structural strength and to understand any technical hurdles.



Segmental Retaining Wall Options

Hand-Placed Units

- Smaller SRW units that offer versatile, structurally stable, and simplistic installation combined with contactor-friendly design features
- Ideal for curved or straight walls and steps
- Perfect choice for anything from small residential planters to complex commercial applications
- Great for projects with limited machine access

Example 1 of Unit Types:

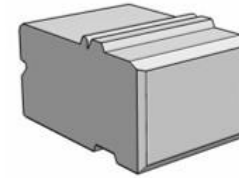

Standard

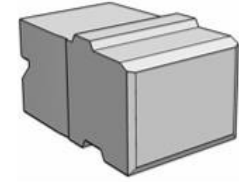

Tapered

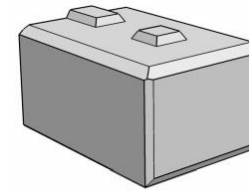

Corner

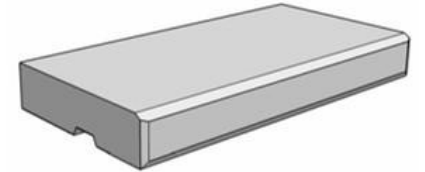

Coping

Example 2 of Unit Types:

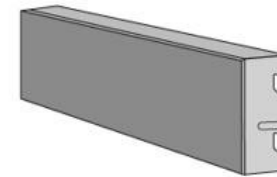

Fascia Panel

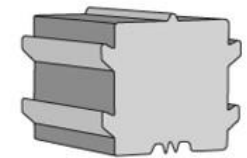

Backer Block

Segmental Retaining Wall Options

Hand-Placed Units: Natural Appearance

- Offers the ease of installation and flexibility of standard SRW units with the appearance of natural stacked flagstone
- Provides distinct real stone textures to achieve a natural, random appearance
- Ideal for residential or high-end commercial projects
- Ability to create curved or straight retaining walls, garden and seat walls, pillars, and planters

Example of Unit Types:

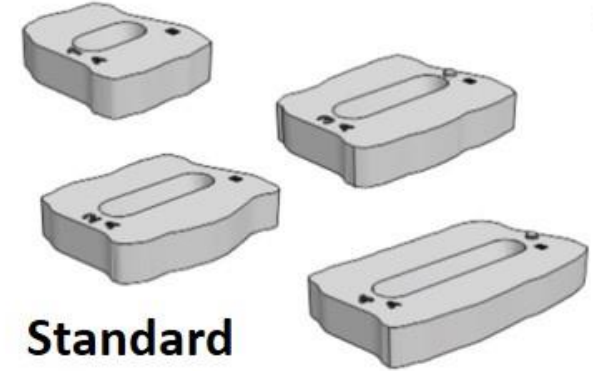

Standard
No. 1, 2, 3 & 4



Long Corner

Short Corner

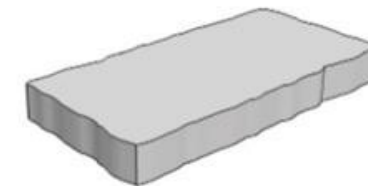

Coping

Segmental Retaining Wall Options

Heavy-Duty and Machine-Placed Units

- Larger SRW units, typically machine-placed, can be used to construct most types of walls (single-depth gravity walls, multidepth gravity walls, crib walls, or geogrid-reinforced walls)
- Blocks can range in depth from 250 mm (9.8") to 1,830 mm (72")
- Suitable for residential and industrial or commercial applications
- Machine-placed units can also increase productivity, decrease labor costs, and contribute toward less labor fatigue

Example 1 of Unit Types:

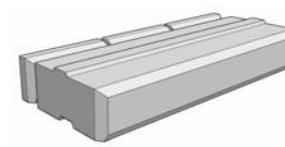

Standard – Depth 1

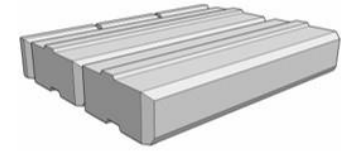

Standard - Depth 2

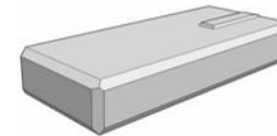

Corner

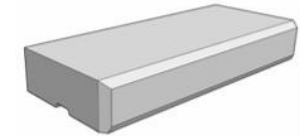

Coping

Example 2 of Unit Types:

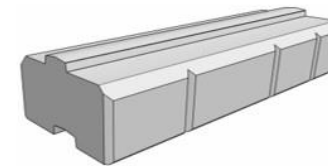

Standard

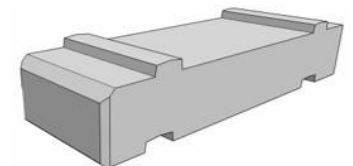

Tie Back

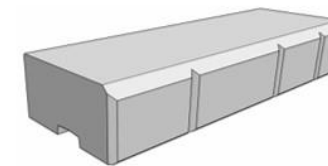

Coping

Advances in Wall Design

SRW units have evolved over the years to meet designer's demands for durability and versatility in wall design. The most recent SRW innovation is a two-component system composed of backer blocks and fascia panels. This system allows for patterning, inlays, and texture changes because of the availability of various colors and finishes. It also incorporates the same face mix technology used in paver manufacturing to create durable exterior facades with refined surfaces and long-lasting color.

The revolutionary system gives designers the ability to embrace creativity and extend patterning and finishes from groundwork to vertical hardscaping elements.

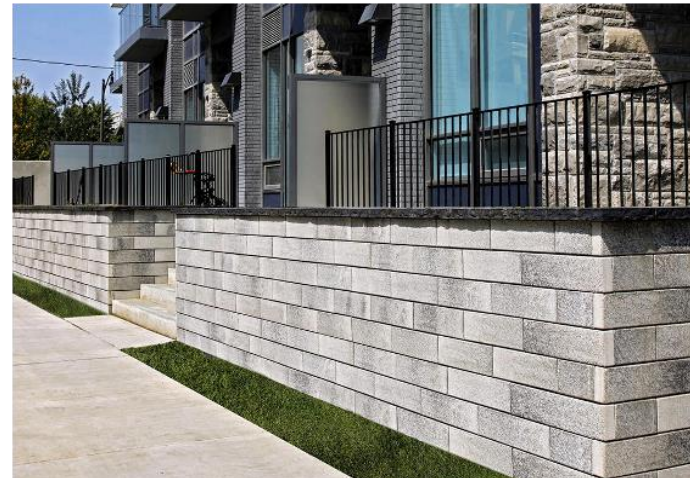
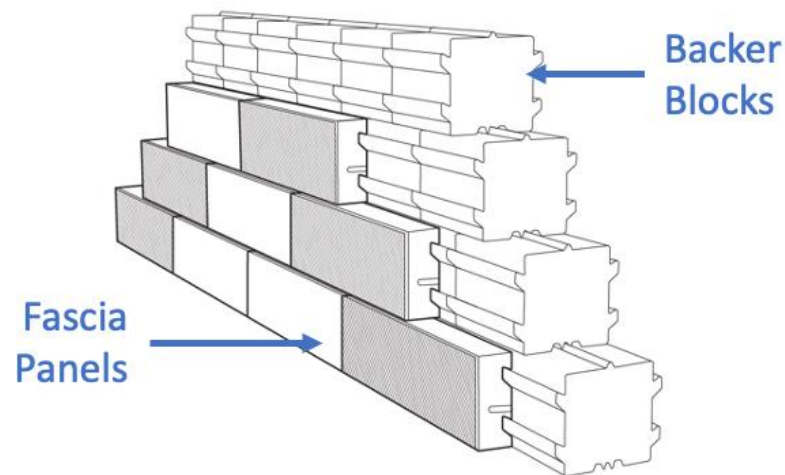

Advances in Wall Design

This advance in wall design offers more design opportunities for structural and nonstructural walls. It is suitable for seat walls, garden walls, geogrid-reinforced SRWs, and gravity walls under 3' (0.9 m). This type of segmental retaining wall unit is also ideal for projects with limited machine access.

Gravity Wall under 3'

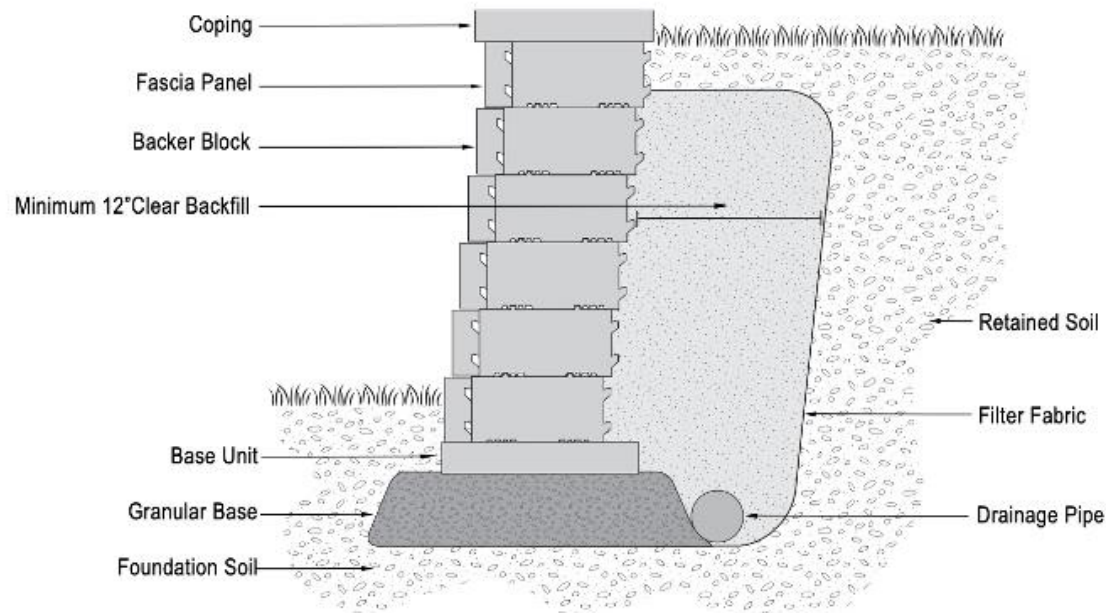

Typical Cross Section (Not for Construction)

Geogrid-Reinforced Wall

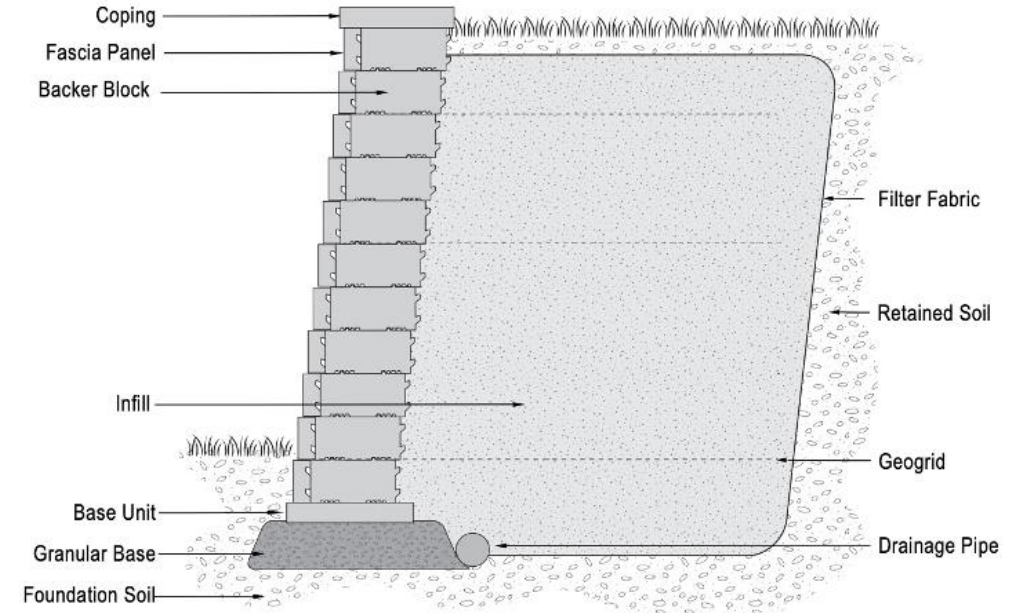

Typical Cross Section (Not for Construction)

Benefits of Designing with SRWs



Benefits: Ease & Rate of Installation

SRWs are typically installed faster than other types of walls.

Units are dimensionally accurate and are therefore easy to stack.

The units have a tongue-and-groove system molded directly into the block to provide automatic alignment and structural stability. This system maintains the shear strength of the wall along the entire length.

Solid concrete blocks are easy to split and modify on-site with no risk to the integrity of the SRW being constructed.

For machine-placed SRWs, the installation rate is between 300 and 1000 ft² per day without specialized labor. This is ideal for tight timelines and schedules.



Benefits: Design Flexibility

Due to the segmented nature of SRWs, the size and weight of the units permit construction in difficult-to-access locations.

SRW units may range from 19 lb (8.6 kg) to 1,700 lb (772.7 kg), and some can be used to construct walls up to 40' (12.2 m) high.

This type of wall system also allows for design flexibility to create complex architectural layouts, including straight or curved (convex or concave) walls, tiered or terraced walls, corners, and stairs.

SRWs can also be designed to have far superior appearance than other types of walls, with varying colors, textures, sizes, and shapes.



Benefits: Flexibility

Since they are not mortared together, they can accommodate movement and settlement without failing. As a result, in most cases, the wall does not have to be founded below the frost line (typically around 4' deep) as we do with rigid structures such as reinforced concrete walls.

The normal embedment for SRWs is around 10% of the wall height. This saves significant time and money in excavation.



Benefits: Dry-Stack Drainage

Dry-stack construction of an SRW allows water to drain through the face of the wall. This helps prevent hydrostatic pressure from building up behind the wall.

It is important to note that it is still essential to ensure there is a well-designed and well-constructed drainage system behind the SRW.

★ Please remember the **test password ROOFTOP**. You will be required to enter it in order to proceed with the online test.



Technical Assistance

From providing general product information, typical cross sections, and software programs to site-specific final design packages, manufacturers can work with you to achieve the best possible design solution.

SRW design software, usually proprietary to individual manufacturers, allows wall designers to:

- accurately display the true footprint of the wall
- create elevation views
- generate accurate reports and final design submission drawings
- import grading and layout information directly from other CAD (computer-aided design) software
- run static, seismic, and ICS (internal compound stability) analysis in accordance with industry standards, and
- generate quantity estimates and project-specific reports.

Remember to consult individual manufacturers for specific details pertaining to their SRW design and construction services.

SRW Projects

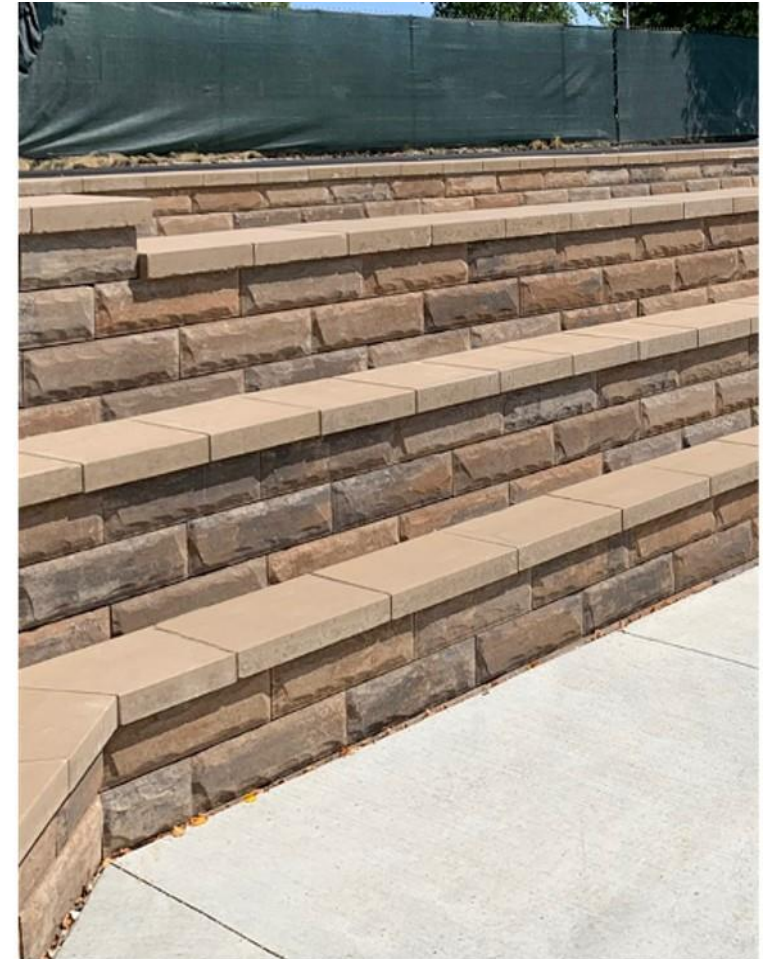
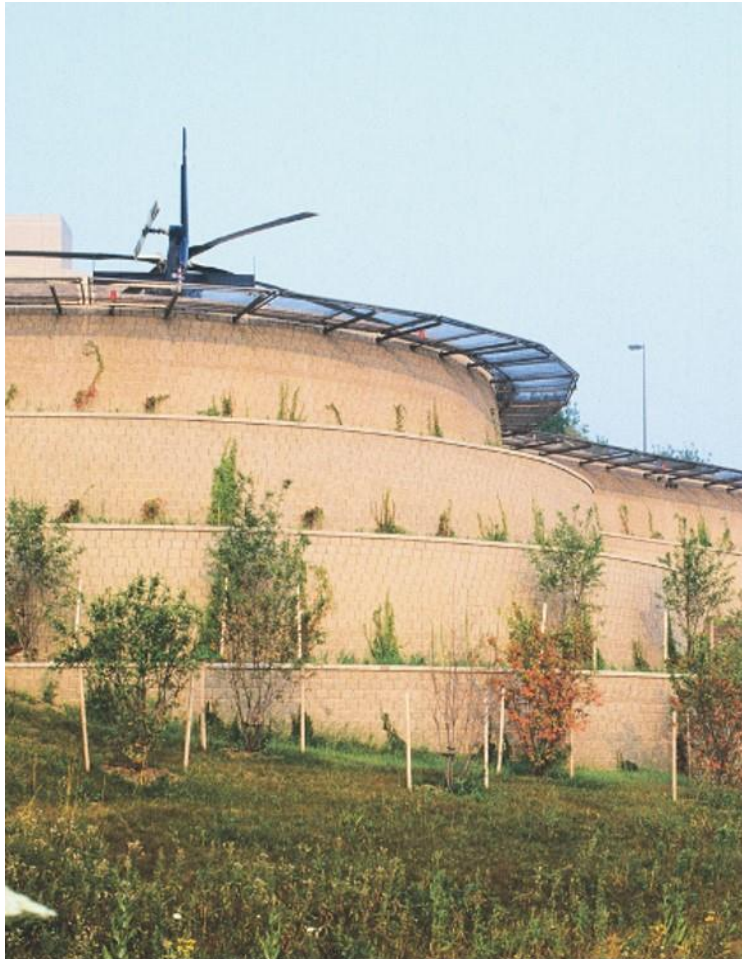

Going to New Heights with SRWs



Project: University of Michigan Helipad, Ann Arbor, MI
Designer: Albert Kahn & Associates Inc.

This project was designed with smaller SRW units that have proven structural integrity. They provided the color, texture, and design flexibility needed to meet the aesthetic requirements of the project, including the creation of curved and straight walls. These units were also able to offer versatile, structurally stable, and simple installation with contactor-friendly design features.

Creating New Space with SRWs



Project: Roxbury Latin School, Roxbury, MA

Designer: Stantec

At Roxbury Latin School, the terrain of the property presented elevation challenges that were easily solved with the installation of two different types of segmental retaining walls. Hand-placed SRW units shore up the perimeter of the new tennis courts, and large SRW units create the engineered retaining wall required for the new baseball diamond backstop and team areas.

An access road was created to get to the new outdoor athletic facility, and again, the grade drop-off to the baseball diamond presented a challenge. This was solved with an engineered wall built with the same SRW units that were used for the perimeter of the tennis courts to support the load of the new two-lane road access.

Versatility of SRWs



Project: Burning Bush Park, Mount Prospect, IL
Designer: Christopher B. Burke Engineering

This design needed to address new grade changes on the site. In order to meet the aesthetic goals of the project, a modern and innovative retaining wall with interchangeable fascia panels was used to carve out the new field space and create terraced seating behind the backstop of the baseball diamond.

The nature of the segmental units also allowed for gradual height changes in the wall design to account for the sloped ramp down into the field. The versatility of this wall allowed for maximization of the space by integrating practical park-user seating directly into the retaining wall.

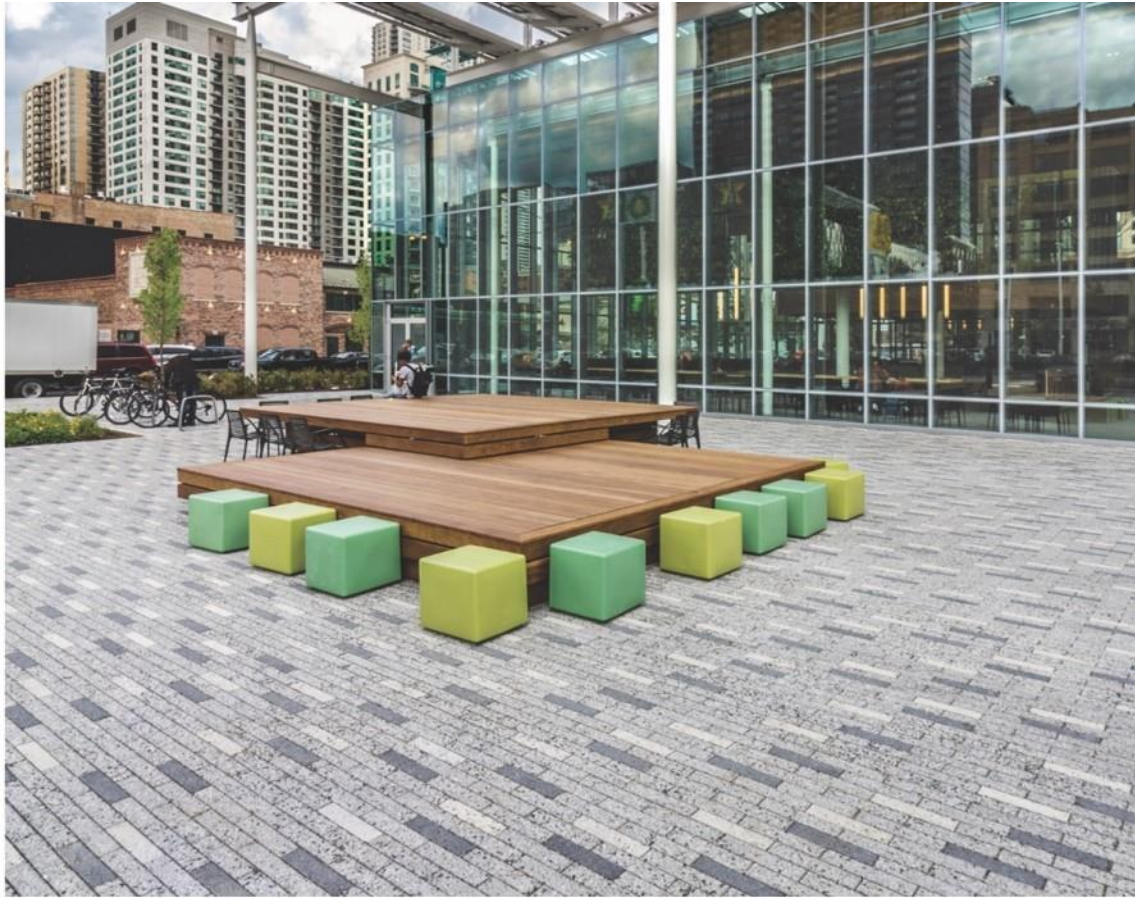

Resources

Resources

ConcreteNetwork.com, n.d., <http://www.concretenetwork.com/>. Accessed Apr. 2021.

Inglesby, Tom. “Block on Block: A Brief History of Segmental Retaining Walls.” *Mason Contractors Association of America (MCAA)*, 18 Aug. 2004, <https://www.masoncontractors.org/2004/08/18/block-on-block-a-brief-history-of-segmental-retaining-walls/#newsletter>. Accessed Apr. 2021.

National Concrete Masonry Association (NCMA), n.d., <https://ncma.org/>. Accessed Apr. 2021.

RisiStone. Risi Stone Inc., n.d., <https://www.risistone.com/>. Accessed Apr. 2021.

Conclusion

If you desire AIA/CES, state licensing, or CE credits for another organization, please click on the button to commence your online test. A score of 80% or better will allow you to print your Certificate of Completion; you may also go to your AEC Daily Transcript to see your completed courses and certificates.

For additional knowledge and postseminar assistance, click on the Ask an Expert link.

If you have colleagues who might benefit from this seminar, please let them know. Feel free to revisit the AEC Daily website to download additional programs.

MORE >

powered by  **@AEC DAILY.**
www.aecdaily.com



©2021 Unilock. The material contained in this course was researched, assembled, and produced by Unilock and remains its property. Questions or concerns about the content of this course should be directed to the program instructor. This multimedia product is the copyright of AEC Daily.

Questions? Ask an Expert – [click here](#)

Click Here to Take the Test

Exit